

# PRODUCT CATALOG 2024



Last Update 02/09/2024



ISO 9001 CERTIFIED  
ISO 13485 CERTIFIED

## TABLE OF CONTENTS

<b>About IVEK</b> .....	4
<b>Technical Overview</b>	
System Components.....	6
Control Modes.....	10
Channel Configurations.....	10
<b>Pump Modules</b>	
Micro Rotary and SR Pump Modules.....	11
Sanitary Split Case Pump Module.....	14
Heavy Duty 5ml Pump Module.....	16
MegaSpense® Pump Module.....	17
Micro Linear Pump Module.....	18
Micro Linear SL Pump Module.....	20
Macro Linear Pump Module.....	22
SF and LF Multiplex Pump Modules.....	24
<b>Motor Bases and Actuators</b>	
MicroSpense® AP Motor Base.....	26
Heavy Duty Motor Base.....	29
MegaSpense®.....	31
Micro and Macro Linear Actuators.....	33
Multiplex Actuator.....	36
<b>Single Channel Dispensing Systems</b>	
ElectroSpense®.....	38
DigiSpense® 3009.....	40
DigiSpense® 3020.....	42
DigiSpense® 4000.....	44
<b>Multiple Channel Dispensing Systems</b>	
MultiSpense® 900.....	47
MultiSpense® 2000.....	47
Multiplex.....	50

**Specialty Systems**

Methaspense® Controlled Substance Dispensing Systems.....52  
 DigiSpense® 1000 Controlled Substance Dispensing System .....53  
 Controlled Substance Dispensing Station.....54  
 Digispense® Striper (Reagent Dispensing for LFA).....55  
 Digisonic III – Ultrasonic Atomization System.....57  
 Sonicair – Atomizing Systems.....59

**OEM Products and Services**

OEM Services.....61  
 Ceramic Liquid Valves and Valve Components.....62  
 Autopipettor – Precision Aspirating and Dispensing Module.....63  
 Displacement Pump – Size 11.....66  
 Displacement Pump – Size 17.....69  
 Metering Pumps.....72

**Accessories**

Fluid Circulation Module.....74  
 Heater System .....75  
 Liquid Eye - Optical Liquid Detector.....76  
 Small Volume Dispense Nozzles.....78  
 Degasser.....78  
 Validation Guidelines .....79

**Terms and Conditions of Sale.....80**

Please contact our technical sales office with any questions or inquiries. Have your application tested free of charge. Visitors always welcome to our manufacturing facility in Vermont.  
 IVEK Corporation • 10 Fairbanks Road • North Springfield • Vermont • USA • 05150  
 tel: (01) 802.886.2238 • fax: (01) 802.886.8274

## ABOUT IVEK

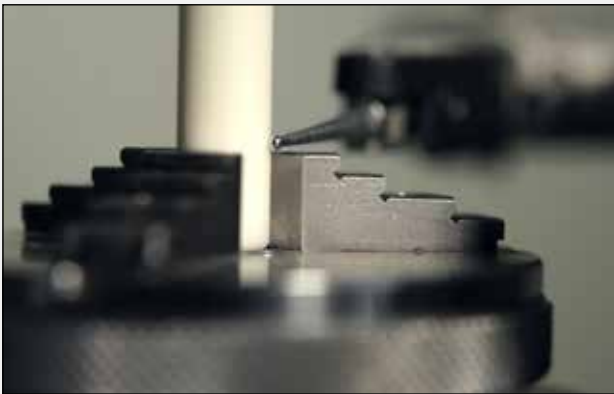

## Since 1979

IVEK Corporation has been designing and manufacturing precision small volume Fluid Metering and Dispensing Systems since 1979. Exceptional fluid control over small volumes is the specialty of our Liquid Dispensers and Metering Pumps. IVEK products are custom specified and free application testing helps us accurately assess requirements and define customer expectations.

## Quality Products

Our products are relied upon for critical applications and our policy states customer satisfaction as the number one priority. Every product undergoes extensive testing and quality checks to ensure reliability. IVEK is ISO 9001 and ISO 13485 certified.

## Innovative Design

Utilizing the finest quality precision instruments in the world, IVEK's in-house engineering staff designs and customizes its products to satisfy application requirements as necessary. We are committed to continuous improvement and maintaining state-of-the-art design capabilities.

## Our Mission

To achieve customer satisfaction and to enhance the professional experience of our staff through the progressive and innovative manufacture of precision liquid metering and dispensing equipment.

### Precision Manufacturing

IVEK controls critical processes through in-house manufacturing. Maintaining control over these processes has increased our quality, reliability and performance. This also allows for flexibility of delivery for our customers when needed.

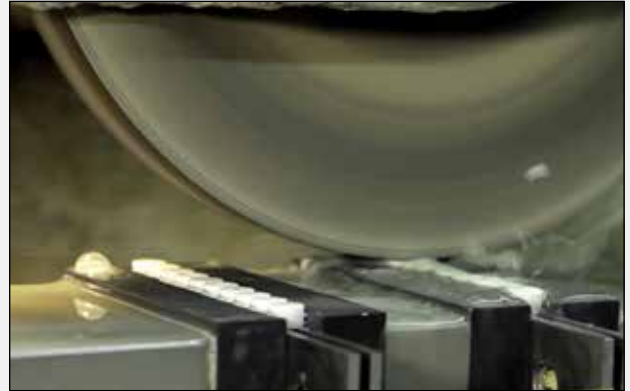

### Customer Support

Our company policy states customer satisfaction as the number one priority. Our experience has proven that applications analysis and technical support are essential for each project. Technical Support staff is available in-house or worldwide travel to provide installation assistance and problem solving.

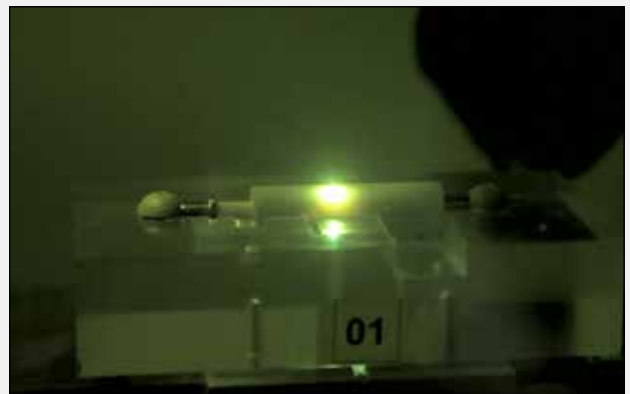

### Committed to Environment

IVEK is proud to participate in the goal of energy independence and investing in green, sustainable technologies. Our two solar panel arrays consisting of over 1750 solar panels at our facility in Vermont generates 100% of our electrical needs, including manufacturing.



### Proudly Made in the USA

IVEK is located in North Springfield, Vermont and has expanded here since its inception. All of IVEK's products are specified, designed and manufactured at this location. We encourage and welcome visits to our facility in Vermont at any time.



## SYSTEM COMPONENTS

An IVEK fluid handling system consists of three main components: pump module(s), motor base(s) or actuator(s) and a controller.



pump module



actuators



controller

### (1) Pump Module:

The IVEK pump module incorporates a ceramic piston/valve/cylinder set with housing. The housing for IVEK's piston/valve/cylinder sets are typically comprised of 316 Stainless Steel or Tefzel. Custom materials can be used and are available upon request. The piston/valve/cylinder set is sealed by the fit of the piston into the cylinder. IVEK pump modules are positive displacement mechanisms that do not contain external valves, are extremely hard and resist abrasion, resulting in a system that exhibits little to no wear even after hundreds of millions of cycles. In addition, the ceramics are compatible with most acids and bases. The natural crystalline structure of the ceramics displays zero porosity, which insures zero retention and carry-over of one biological fluid to the next.

There are three types of pump modules: Rotary, Linear and Multiplex which are used for different applications depending upon the customer's fluidic needs. These pump modules function differently based on the drive system, however they share the same basic features that result in a low maintenance pump module.

#### Features:

- Mated, serialized piston/valve/cylinder sets
- Low dead volume & tight clearance 2.3-5.3 microns
- Minimal friction
- Low fluid shear
- No particulate generation
- Can be autoclaved and sterilized under most cleaning procedures
- Chemically inert – most acids, alkalines or solvents do not affect the ceramics
- Extremely hard – resist abrasion & wear
- No external seals needed due to tight clearance of piston/cylinder
- Titanium end cap press fit onto piston - eliminates adhesive contamination problems
- Low maintenance
- Flushing gland available to help eliminate binding issues with certain fluids

## SYSTEM COMPONENTS

The three types of pump modules are as follows:

### a) Rotary:

Rotary systems use an offset drive to create simultaneous rotary and linear motion on the piston. Each single 360° rotation of the motor results in an intake and discharge cycle. The stroke length of the piston (displacement) is mechanically adjusted. The rate the piston travels is electronically adjusted through the motor speed. Rotary systems can be configured into single or multiple channel metering or dispensing systems. The flow profile of a single stroke (volume over time) is sinusoidal. The fluid delivery can be in individual strokes or multiple strokes. Stroke selection is via a Controller Module setting. Multiple strokes can be delivered at up to 1500 strokes per minute (1500 RPM). Rotary Motor/ Base Modules can be single ended (single shafted motor with one Pump Module) or dual ended (double shafted motor with two Pump Modules – one on each end). One use of the dual ended configuration is mixing two fluids at an accurate ratio, regardless of flow rate.

### b) Linear:

Linear Systems use a linear actuator (motor/lead-screw combination) to drive a single two-piece ceramic pump module. The actuator can either drive the piston in a linear motion for displacement or in a rotary motion to accomplish valving. Dispense volume is digitally selected through the controller to produce a pulse free linear flow. These systems can be configured into single or multiple channel metering or dispensing systems. Nanoliter volume resolution can be attained.

### c) Multiplex:

The Multiplex series use a single motor and two lead-screws to simultaneously drive multiple three-piece ceramic pump modules. The motor and lead-screw combination drive the pistons in a linear motion to create displacement. Each Pump Module has an air driven rotary actuator to turn the valve towards the intake or discharge port. Dispense volume is digitally selected through an RS232 computer signal or touch screen to produce a pulse free linear flow.

ROTARY SYSTEM		LINEAR SYSTEM			MULTIPLEX SYSTEM		
PUMP SIZE	MAXIMUM DISPLACEMENT	PUMP SIZE	CHAMBER CAPACITY	RESOLUTION*	PUMP SIZE	CHAMBER CAPACITY	RESOLUTION*
3A	27µl	4A	20µl	0.002µl	200	200µl	0.005µl
2A	54µl	3A	50µl	0.005µl	400	400µl	0.01µl
A	109µl	2A	100µl	0.01µl	2000	2000µl	0.05µl
B	295µl	A	200µl	0.02µl	4000	4000µl	0.1µl
C	739µl	B	400µl	0.04µl	5000	5000µl	0.125µl
D	1478µl	C	1000µl	0.1µl			
16mm	1886µl	D	2000µl	0.2µl			
HD+	5000µl						
G	15000µl						

\* volume selection increments - minimum dispense volume depends on the liquid's properties.

TECHNICAL OVERVIEW

FLUID INTAKE & DISCHARGE BY ACTUATOR TYPE

ROTARY\*

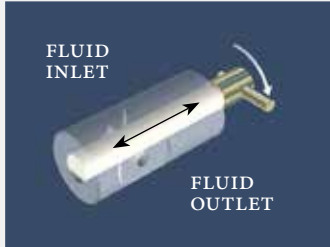

THE PISTON IS SHOWN AT BOTTOM DEAD CENTER OF ITS STROKE. BOTH INLET AND OUTLET PORTS ARE CLOSED AND PISTON FLAT IS ROTATING TOWARD THE INLET PORT.

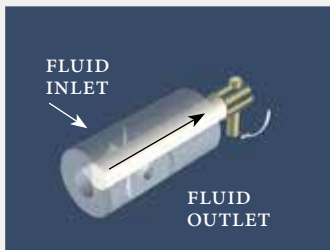

SUCTION IS CREATED DURING THE INTAKE STROKE BY THE PISTON RETRACTING INSIDE THE CYLINDER. THE PISTON FLAT OPENS THE INLET PORT TO THE PUMP CHAMBER AND THE OUTLET PORT IS CLOSED.

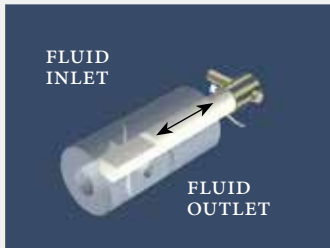

THE PISTON IS SHOWN AT TOP DEAD CENTER OF ITS STROKE. BOTH THE INLET AND OUTLET PORTS ARE CLOSED AND PISTON FLAT IS ROTATING TOWARD THE OUTLET PORT.

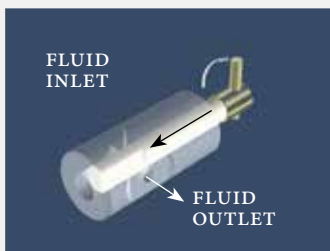

POSITIVE DISPLACEMENT IS CREATED DURING THE DISCHARGE STROKE AS THE PISTON ADVANCES INSIDE THE CYLINDER. THE PISTON FLAT OPENS THE OUTLET PORT TO THE PUMP CHAMBER AND THE INLET PORT IS CLOSED.

DIGISPENSE®/MULTISPENSE®\*

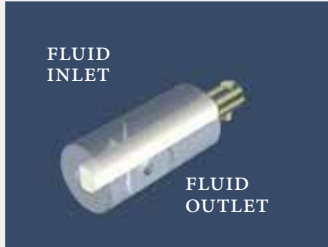

THE PISTON IS SHOWN AT THE BEGINNING OF THE INTAKE STROKE. THE FLAT ON THE PISTON OPENS THE INLET PORT TO THE PUMP CHAMBER AND THE OUTLET PORT IS CLOSED.

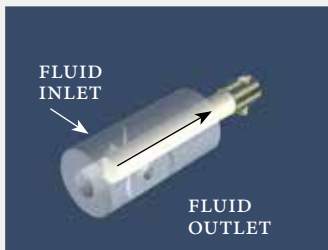

SUCTION IS CREATED DURING THE INTAKE STROKE BY THE LINEAR MOTION OF THE PISTON.

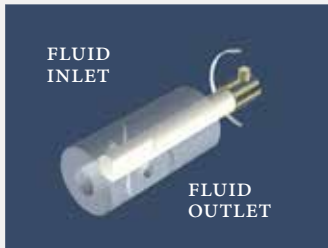

THE PISTON ROTATES 180° AND THE FLAT ON THE PISTON OPENS THE OUTLET PORT TO THE PUMP CHAMBER – THE INLET PORT IS CLOSED.

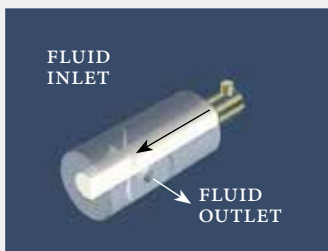

POSITIVE DISPLACEMENT IS CREATED DURING THE DISCHARGE STROKE BY LINEAR MOTION OF THE PISTON.

MULTIPLEX

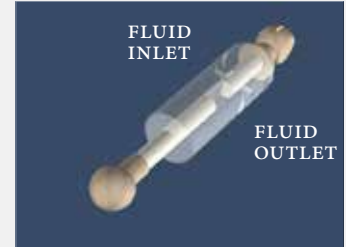

THE MODULE IS SHOWN AT THE BEGINNING OF THE INTAKE STROKE. THE FLAT ON THE VALVE OPENS THE INLET PORT TO THE PUMP CHAMBER AND THE OUTLET PORT IS CLOSED.

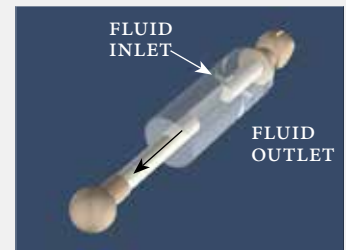

SUCTION IS CREATED DURING THE INTAKE STROKE BY THE LINEAR MOTION OF THE PISTON.

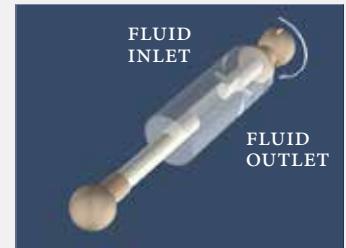

THE VALVE ROTATES 180° AND THE FLAT OPENS THE OUTLET PORT TO THE PUMP CHAMBER – THE INLET PORT IS CLOSED.

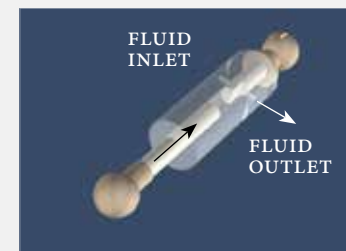

IN THE DISCHARGE STROKE POSITIVE DISPLACEMENT IS CREATED BY THE LINEAR MOTION OF THE PISTON.

\*CYLINDER END SEAL REMOVED FOR ILLUSTRATION



## SYSTEM COMPONENTS

### (2)Motor/Base or Actuator Module:

The Motor/Base or Actuator Module drives the Pump Module. There are three main varieties that correspond to the Pump Module types. The Motor/Base or Actuator Module drives the piston in a linear direction for the intake and discharge functions. Rotary motion is used for the valving function.

#### Motor/base or actuators available include:

##### Heavy duty Motor Base (rotary system)

- Used for larger dispenses
- Different motor sizes available for various fluid viscosities

##### AP Motor Base (rotary system)

- Auto Prime allows user to easily return to a pre-calibrated setting after priming/cleaning
- Used for smaller dispenses
- Fire off small volumes

##### DC brushless (rotary system)

- Used for larger dispenses that require speed
- Dedicated to DigiSpense® 10 Controller
- Fire off small volumes
- High through put applications of more than 200 parts/minute

##### 20-pitch Actuator (linear system)

- Stepping motor and lead screw combination
- Used for larger dispenses
- Linear flow profile

##### 40-pitch Actuator (linear system)

- Stepping motor and lead screw combination
- Used for smaller dispenses
- Linear flow profile

##### Multiplex Actuator

- Can operate up to 12 pumps simultaneously
- Piston/Cylinder is driven by both a linear and rotary motion
- 40,000 increment resolution

## SYSTEM COMPONENTS

### (3)Controller Module:

IVEK Corporation designs and manufactures its own dedicated electronics for the product line. The electronics are specifically designed to maximize fluidic performance. Forward and reverse fluid movement, linear adjustable rate control, volume select, prime and dispense modes and drawback, for shearing viscous materials, are a partial list of the control options available. The Controller Module can also include an operator interface panel to set parameters and signal alarms. Multiple channels, PLC interfacing, RS232 communication, alarm systems and cycle outputs as well as custom options are configured, as the application requires. Custom OEM enclosures are available (e.g. Stainless Steel, NEMA 4X). CE marking upon request.

## CONTROL MODES

There are two main types of control modes as follows:

### I. Dispensing:

Measured additions of fluid are displaced upon command. Dispensing applications are described as a volume per fill at a specific rate (ex. 0.5ml/package) Examples include:

- Bottle/vial filling
- Silicone dispensing
- Fragrance dispensing
- Colorant dispensing
- Silicone dispensing for syringe lubrication
- Blister packs
- Drug coatings
- Battery electrolyte dispensing
- Contact lens monomer dispensing
- Many more

### II. Metering:

Continuous additions of liquid over time. Metering applications are described as a flow rate (ex.: ml/min). Examples include:

- Flavor additions in continuous food processing
- pH control for waste water treatment
- Electroplating bath replenishment
- Many more

## CHANNEL CONFIGURATIONS

IVEK offers both single and multiple channel configurations. A channel refers to a single Motor/Base or Actuator Module driven by a Controller Module. Single Channel systems are often bench-top units. Multiple Channel systems are often integrated into a production application to fill many vessels at once. While most systems have one pump per channel, Dual-Ended Rotary systems have two pumps per channel and Multiplex systems have eight, ten, or twelve pumps per channel.

## MICRO ROTARY AND MICRO SR PUMP MODULES

The Micro Rotary and Micro SR (Sanitary Rotary) Pump Modules are comprised of a ceramic piston fabrication and mated ceramic cylinder pressed into a case having intake and discharge ports. The Pump Modules are designed for easy detachment from the Motor/Base Module and disassembly for ease of cleaning, decontamination and sterilization. The intake and discharge ports accept either 1/4-28 or 5/16-24 universal fittings. Three sizes of Micro Rotary and Micro SR Pump Module are available to meet specific dosing requirements. These Pump Modules are designed for use with IVEK's MicroSpense® AP Motor/Base Modules.

### Features:

- Available in three sizes: "A" (0-109µl), "2A" (0-54µl), "3A" (0-27µl)
- Positive displacement piston cylinder design made from 99.8% alumina oxide (Al<sub>2</sub>O<sub>3</sub>) or zirconia (MGO partially stabilized TTZ)
- Individually laser serialized piston/cylinder sets
- Case material: Tefzel (other material available on a custom basis)
- Port connections: 1/4-28 UNF.2-B or 5/16-24 UNF.2-A
- Wetted materials include ceramic, elastomeric o-ring/sapphire or Teflon
- Teflon end seals are available for CIP applications
- Resists routine autoclaving and sterilization procedures
- Seal-less design
- Wide variety of standard fittings available
- Low Friction
- Low fluid shear

size	maximum displacement per stroke	minimum displacement per stroke
3A	27µl	1µl
2A	54µl	5µl
A	109µl	10µl



Micro Rotary Pump Module



Micro SR Pump Module

These Pump Modules can be used with the following module:

- MicroSpense® AP Motor/Base Module

## MICRO ROTARY PUMP MODULE

### Micro Rotary Pump Module:

w/ Teflon End Cap	102103 -	#	#	#	#
w/ Sight Glass End Cap	102109 -	#	#	#	#

#### End Cap Retainer Material

- 1 - White Delrin
- 2 - 303 Stainless Steel

#### O-Ring Material (static head seal)

- 1 - Buna-N
- 2 - Ethylene Propylene
- 3 - Kalrez
- 4 - Polyurethane
- 5 - Silicone
- 6 - Teflon
- 7 - Teflon Encapsulated Silicone
- 8 - Viton
- 9 - Teflon Encapsulated Viton

#### Pump Case Size

- 1 - 1/4-28
- 2 - 5/16-24

#### Ceramic Size and Piston/Cylinder Material

- 1 - 3A, HIP'd-YTZP/Mag Zirc
- 2 - A, Mag Zirc
- 3 - 2A, Mag Zirc
- 4 - 2A, Alumina
- 5 - 1A, Mag Zirc
- 6 - 1A, Alumina
- A - 3A, HIP'd-YTZP/Mag Zirc, w/ Gland
- B - 3A, Mag Zirc, w/ Gland
- C - 2A, Mag Zirc, w/ Gland
- D - 2A, Alumina, w/ Gland
- E - 1A, Mag Zirc, w/ Gland
- F - 1A Alumina, w/ Gland

## MICRO SR PUMP MODULE

### Micro SR (Sanitary Rotary) Pump Module:

250021 - # # # # # ##

**End Cap Material**

- 1 - Sight Glass
- 2 - Teflon

**O-Ring Material**

- 1 - Buna-N
- 2 - Ethylene Propylene
- 3 - Kalrez
- 4 - Polyurethane
- 5 - Silicone
- 6 - Teflon Encapsulated Silicone
- 7 - Viton
- 8 - Teflon Encapsulated Viton

**O-Ring Quantity**

- 1 - 1
- 2 - 2

**End Cap Retainer**

- 1 - Delrin
- 2 - 316 Stainless Steel

**Port Size / Case Material**

- 1 - 1/4-28 / Delrin
- 2 - 5/16-24 / Delrin
- 3 - 1/4-28 / Stainless Steel
- 4 - 5/16-24 / Stainless Steel

**Ceramic Size and Material**

- 01 - 3A HIP'd/YTZP
- 02 - 3A HIP'd/YTZP w/ Gland
- 03 - 3A Mag Zirc
- 04 - 3A Mag Zirc w/ Gland
- 05 - 2A Mag Zirc
- 06 - 2A Mag Zirc w/ Gland
- 07 - 2A Alumina
- 08 - 2A Alumina w/ Gland
- 09 - 1A Mag Zirc
- 10 - 1A Mag Zirc w/ Gland
- 11 - 1A Alumina
- 12 - 1A Alumina w/ Gland
- 13 - 1A Hex SA SIC
- 14 - 1A Hex SA SIC w/ Gland

## SANITARY SPLIT CASE PUMP MODULE

IVEK's Sanitary Split Case pump module is unique among positive displacement rotary and reciprocating piston pumps. It is designed to allow the quick disassembly of all the pump module components and/or the removal and return of the entire pump module from the motor/base group without recalibration. The simple break down of all the wetted components enhances cleaning and the module can be autoclaved. An optional gauge can be used to calibrate this pump module without running fluid. This eliminates possible contamination or the loss of expensive or controlled fluid. All aspects of a 'user friendly' design and customer suggestions were considered during the pump module's development in order to allow fluid to flow freely, unobstructed through the wetted components without exposure to dead volume areas such as cracks, crevices, or threads. Constructed from cast 316 stainless steel, this heavy-duty pump module is extremely durable and stable, and will maintain calibration and accuracy for the most difficult applications.

### Features:

- Disassembles in less than 30 seconds
- Stroke length calibration is retained after disassembly
- Ceramics can be autoclaved independently
- Easily replaceable high performance Teflon or custom seals
- Easily interchanged
- Self-priming
- Cleaning commonly accomplished through flushing procedure (CIP)
- Heater cartridge ports option for elevated temperature requirements

### Adapter Fitting Systems:

- Efficient flow design – no dead legs
- Variety of standard choices
- Custom fittings available on request
- Easy assembly/disassembly
- Standard materials: stainless, polypropylene, Tefzel
- Custom materials available including PEEK and Kynar
- Adapters to link to all fitting types
- Sanitary, chemically resistant design

This Pump Module can be used with the following module:

- Heavy Duty Motor Base Module



Assembled Split Case Pump Module

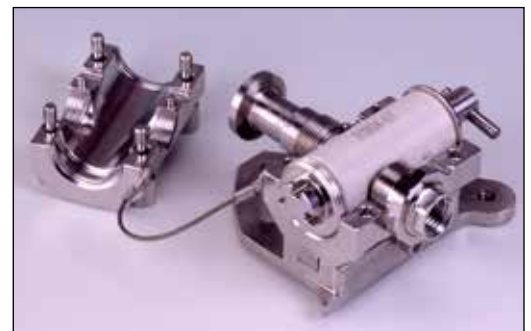

Pump Module, top half of case removed



Disassembled Split Case

## SANITARY SPLIT CASE PUMP MODULE

**Ceramic Pump Module Features:**

- High purity alumina or zirconia ceramic
- Pump sizes: "B" (0-295µl), "C" (0-739µl), "D" (0-1478µl), and 16mm(0-1886µl)
- Custom modifications available
- Laser-etched serial numbers on each part
- Parts matched to +/- 20 millionths of an inch

piston size	max stroke capacity
B	295µl
C	739µl
D	1478µl
16mm	1886µl

**Sanitary Split Case Pump Module:**

092122 - # # ###

**Case Type**

- 1 - No Heater Ports, 420SS Locating Key
- 2 - Heater Ports, 420SS Locating Key
- 3 - No Heater Ports, 316SS Locating Key
- 4 - Heater Ports, 316SS Locating Key

**O-Ring Material (static head seal)**

- 1 - Buna-N
- 2 - Ethylene Propylene
- 3 - Kalrez
- 4 - Polyurethane
- 5 - Silicone
- 6 - Teflon
- 7 - Teflon Encapsulated Silicone
- 8 - Viton

**Ceramic Size and Material**

- |                               |                                  |
|-------------------------------|----------------------------------|
| 001- B-Size Alumina           | 103- C-Size Alumina w/ Gland     |
| 002- B-Size Zirconia          | 104- C-Size Zirconia w/ Gland    |
| 003- C-Size Alumina           | 105- D-Size Alumina w/ Gland     |
| 004- C-Size Zirconia          | 106- D-Size Zirconia w/ Gland    |
| 005- D-Size Alumina           | 113- 16mm -Size Alumina w/ Gland |
| 006- D-Size Zirconia          | 115- B-Size HEX SA SIC w/ Gland  |
| 013- 16mm-Size Alumina        | 117- C-Size HEX SA SIC w/ Gland  |
| 015- B-Size HEX SA SIC        | 119- D-Size HEX SA SIC w/ Gland  |
| 017- C-Size HEX SA SIC        |                                  |
| 019- D-Size HEX SA SIC        |                                  |
| 101- B-Size Alumina w/ Gland  |                                  |
| 102- B-Size Zirconia w/ Gland |                                  |

## HEAVY DUTY PLUS 5ML PUMP MODULE

The Heavy Duty Plus Pump Module is comprised of a ceramic piston fabrication and mated ceramic cylinder in a case having intake and discharge ports. The HD+ Pump Modules are designed for easy detachment from the Motor/Base Module and disassembly for ease of cleaning, decontamination and sterilization. The intake and discharge ports a wide variety of stainless steel or plastic fittings available through IVEK. The HD+ Pump Modules are designed for use with IVEK's Heavy Duty Motor/Base Modules.

**Features:**

- Displacement 5mL per stroke
- Positive displacement piston cylinder design made from 99.5% alumina oxide (Al<sub>2</sub>O<sub>3</sub>)
- Individually laser serialized piston/cylinder sets
- Case material: 316 Stainless Steel
- Wetted materials include ceramic, o-ring and PTFE
- Resists routine autoclaving and sterilization procedures
- Seal-less design
- Wide variety of standard fittings available
- Low Friction
- Low fluid shear
- Module can be heated



Heavy Duty 5ml Pump Module (fittings not included with module)

<b>Heavy Duty Plus 5ml Pump Module:</b>	<b>092342</b>	-	<b>##</b>	<b>#</b>	<b>#</b>	<b>#</b>	<b>#</b>	<b>#</b>
<b>Displacement</b>	05 - 5 ml							
<b>Port Size</b>	0 - 6.35 (.250")							
<b>Piston/Cylinder Material</b>	0 - 99.5% Alumina / 99.5% Alumina							
<b>Gland</b>	0 - w/out Gland 1 - w/ Gland							
<b>Heater Ports and Case Material</b>	0 - w/out Heater Ports, 316 Stainless Steel 1 - w/ Heater Ports, 316 Stainless Steel							
<b>O-Ring Material</b>	1 - Buna -N 2 - EPDM Ethylene Propylene 3 - FFKM Perfluoroelastomer (Black) 4 - Polyurethane 5 - Silicone 8 - FKM Fluoroelastomer (Black)							



## MEGASPENSE® PUMP MODULE

The MegaSpense® pump module from Ivek is the latest in our line of rotary reciprocating pumps. At 15mL maximum displacement per stroke, the MegaSpense® is also our largest pump. The pump module includes IVEK's ceramic piston/cylinder set mounted inside an anodized aluminum case. The MegaSpense® case is designed for quick teardown for cleaning of all components. Volume calibration is maintained after reassembly. An optional gauge can be used to return the pump module to a previously calibrated displacement, simplifying and expediting volume changes. Non-wetted case of anodized aluminum minimizes weight and cost, while the wetted components are typical for other Ivek products - stainless steel fittings and ceramic pumps.

**Features:**

- Disassembles in under five minutes
- Pump displacement calibration retained after disassembly
- Ceramics can be autoclaved independently
- Easily replaceable Teflon or custom seals
- Self priming
- Cleaning commonly accomplished through flushing procedure (CIP)
- Matched and serialized piston/cylinder sets
- Seal-less design
- Low friction
- Low fluid shear

piston size	max stroke capacity
G	15000µl



MegaSpense® Pump Module

**MegaSpense® Pump Module:**

082218 - # # # ## ##

**Size**

0 - G Size Piston/Cylinder

**Gland**

0 - Without Gland

1 - With Gland

**Lip Seal**

0 - Without Lip Seal

**Case Material**

02 - 6061 - T6 Aluminum

00 - 316 SST

**O-Ring Material**

01 - Bona-N

02 - EPDM

03 - Kalrez

04 - Polyurethane

05 - Silicone

08 - FKM

## MICRO LINEAR PUMP MODULE

The Micro Linear Pump Module is comprised of a ceramic piston fabrication and mated ceramic cylinder installed into a case with intake and discharge ports. The Pump Module can be easily detached from the Actuator Module. This allows access to all wetted components for cleaning, decontamination and sterilization. The intake and discharge ports accept either 1/4-28 or 5/16-24 universal fittings. Four sizes of Micro Linear Pump Module are available to meet specific dosing requirements.

**Features:**

- Micro Linear pump sizes include "4A" (20 µl chamber, 0.002 µl resolution), "3A" (50 µl chamber, 0.005 µl resolution), "2A" (100 µl chamber, 0.01 µl resolution), "A" (200 µl chamber, 0.02 µl resolution)
- Individually serialized piston/cylinder sets
- Resists routine autoclaving and sterilization procedures
- Seal-less design
- Can be cleaned in place
- Wide variety of standard fittings available
- Low Friction
- Low fluid shear
- Module can be heated

pump size	chamber capacity	resolution*
4A	20µl	0.002µl
3A	50µl	0.005µl
2A	100µl	0.01µl
A	200µl	0.02µl



Micro Linear Pump Module



Micro Linear Pump Module w/ sight glass end cap

This Pump Module can be used with the following module:

- Linear Actuator Module

## MICRO LINEAR PUMP MODULE

### Micro Linear Pump Module:

SIGHT GLASS END CAP 032127 - # # ##  
 TEFLON END CAP 032145 - # # ##

**End Cap Retainer Material**

- 1 - White Delrin
- 2 - 303 Stainless Steel

**O-Ring Material (static head seal)**

- 1 - Buna-N
- 2 - Ethylene Propylene
- 3 - Kalrez
- 4 - Polyurethane
- 5 - Silicone
- 6 - Teflon (032127 only)
- 7 - Teflon Encapsulated Silicone
- 8 - Viton
- 9 - Teflon Encapsulated Viton

**Pump Case and Ceramic Size, and Material**

- |   |  |
|---|--|
| <ul style="list-style-type: none"> <li>11 - 1/4-28, 4A HIP-YTZP/MAG</li> <li>21 - 5/16-24, 4A HIP-YTZP/MAG ZIRC</li> <li>1A - 1/4-28, 4A HIP-YTZP/MAG ZIRC, W/ GLAND</li> <li>2A - 5/16-24, 4A HIP-YTZP/MAG ZIRC, W/ GLAND</li> <li>12 - 1/4-28, 4A MAG ZIRC/MAG ZIRC</li> <li>22 - 5/16-24, 4A MAG ZIRC/MAG ZIRC</li> <li>1B - 1/4-28, 4A MAG ZIRC/MAG ZIRC, W/ GLAND</li> <li>2B - 5/16-24, 4A MAG ZIRC/MAG ZIRC, W/ GLAND</li> <li>13 - 1/4-28, 3A HIP-YTZP/MAG ZIRC</li> <li>23 - 5/16-24, 3A HIP-YTZP/MAG ZIRC</li> <li>1C - 1/4-28, 3A HIP-YTZP/MAG ZIRC, W/ GLAND</li> <li>2C - 5/16-24, 3A HIP-YTZP/MAG ZIRC, W/ GLAND</li> <li>31 - 1/4-28, 3A HIP-YTZP/ALUMINA</li> <li>42 - 5/16-24, 3A HIP-YTZP/ALUMINA</li> <li>3A - 1/4-28, 3A HIP-YTZP/ALUMINA,W/GLAND</li> <li>4A - 5/16-24, 3A HIP-YTZP/ALUMINA,W/GLAND</li> <li>14 - 1/4-28, 3A MAG ZIRC/MAG ZIRC</li> <li>24 - 5/16-24, 3A MAG ZIRC/MAG ZIRC</li> <li>1D - 1/4-28, 3A MAG ZIRC/MAG ZIRC, W/ GLAND</li> <li>2D - 5/16-24, 3A MAG ZIRC/MAG ZIRC, W/ GLAND</li> </ul> | <ul style="list-style-type: none"> <li>15 - 1/4-28, 2A MAG ZIRC/MAG ZIRC</li> <li>25 - 5/16-24, 2A MAG ZIRC/MAG ZIRC</li> <li>1E - 1/4-28, 2A MAG ZIRC/MAG ZIRC, W/ GLAND</li> <li>2E - 5/16-24, 2A MAG ZIRC/MAG ZIRC, W/ GLAND</li> <li>16 - 1/4-28, 2A ALUMINA/ALUMINA</li> <li>26 - 5/16-24, 2A ALUMINA/ALUMINA</li> <li>1F - 1/4-28, 2A ALUMINA/ALUMINA, W/ GLAND</li> <li>2F - 5/16-24, 2A ALUMINA/ALUMINA, W/ GLAND</li> <li>17 - 1/4-28, 1A MAG ZIRC/MAG ZIRC</li> <li>27 - 5/16-24, 1A MAG ZIRC/MAG ZIRC</li> <li>1G - 1/4-28, 1A MAG ZIRC/MAG ZIRC, W/ GLAND</li> <li>2G - 5/16-24, 1A MAG ZIRC/MAG ZIRC, W/ GLAND</li> <li>18 - 1/4-28, 1A ALUMINA/ALUMINA</li> <li>28 - 5/16-24, 1A ALUMINA/ALUMINA</li> <li>1H - 1/4-28, 1A ALUMINA/ALUMINA, W/ GLAND</li> <li>2H - 5/16-24, 1A ALUMINA/ALUMINA, W/ GLAND</li> <li>19 - 1/4-28, 1A HEX SA SIC/HEX SA SIC</li> <li>29 - 5/16-24, 1A HEX SA SIC/HEX SA SIC</li> <li>1J - 1/4-28, 1A HEX SA SIC/HEX SA SIC, W/ GLAND</li> <li>2J - 5/16-24, 1A HEX SA SIC/HEX SA SIC, W/ GLAND</li> </ul> |
|---|--|

## MICRO LINEAR SL PUMP MODULE

The Micro SL (Sanitary Linear) Pump Module is comprised of the following major components; a ceramic piston fabrication, a cylinder in a case and intake and discharge ports designed to accept a ¼-28 or ⅝-28 male threaded fitting. The Pump Module is within the liquid path and is designed to be detached from the Actuator Module and completely disassembled for ease of cleaning, decontamination and sterilization. This differs from the Micro Linear Pump Module, where the user is not intended to remove the ceramic cylinder from the case.

### Features:

- Micro Linear pump sizes include "4A" (20 µl chamber, 0.002 µl resolution), "3A" (50 µl chamber, 0.005 µl resolution), "2A" (100 µl chamber, 0.01 µl resolution), "A" (200 µl chamber, 0.02 µl resolution)
- Individually serialized piston/cylinder sets
- Resistant to routine autoclaving and sterilization procedures
- Seal-less design
- Can be cleaned in place
- Wide variety of standard fittings available
- Low Friction
- Low fluid shear

pump size	chamber capacity	resolution*
4A	20µl	0.002µl
3A	50µl	0.005µl
2A	100µl	0.01µl
A	200µl	0.02µl



Micro Linear SL Pump Module

This Pump Module can be used with the following module:

- Linear Actuator Module

## MICRO LINEAR SL PUMP MODULE

### Micro Linear SL Pump Module:

032165 - # # # # # # # #

**End Cap Material**

- 1 - Sight Glass
- 2 - Teflon

**End Cap Retainer Material**

- 1 - Delrin
- 2 - 303 Stainless Steel

**O-Ring Material**

- 1 - Buna-N
- 2 - Ethylene Propylene
- 3 - Kalrez
- 4 - Polyurethane
- 5 - Silicone
- 6 - Teflon Encapsulated Silicone
- 7 - Viton
- 8 - Teflon Encapsulated Viton

**O-Ring Quantity**

- 1 - 1
- 2 - 2

**Pump Case Material / Port Size**

- 1 - Tefzel / 1/4 - 28
- 2 - Tefzel / 5/16 - 24
- 3 - 316 Stainless Steel / 1/4 - 28
- 4 - 316 Stainless Steel / 5/16 - 24

**Ceramic Size**

- 1 - 1A
- 2 - 2A
- 3 - 3A
- 4 - 4A

**Ceramic Material**

- 1 - Alumina (not available for 4A size pump)
- 2 - Mag Zirc (HIP/YTZP for 4A size pump)
- 3 - HIP'd YTZP
- 4 - HEX SA SIC (not available in all sizes)

**Gland**

- 1 - Gland
- 2 - No Gland

## MACRO LINEAR PUMP MODULE

The Macro Linear Pump Module is comprised of a ceramic piston fabrication and mated ceramic cylinder, which fits into a stainless steel case with intake and discharge ports. The Pump Module can be easily detached from the Actuator Module. This allows access to all wetted components for cleaning, decontamination and sterilization. The intake and discharge ports accept a wide variety of stainless steel or plastic fittings available through IVEK. Three sizes of Macro Linear Pump Module are available to meet specific dosing requirements.

### Features:

- Macro Linear pump sizes include "B" (400 µl chamber, 0.04 µl resolution), "C" (1000 µl chamber, 0.1 µl resolution), "D" (2000 µl chamber, 0.2 µl resolution)
- Individually serialized piston/cylinder sets
- Resists routine autoclaving and sterilization procedures
- Seal-less design
- Can be cleaned in place
- Wide variety of standard fittings available
- Low Friction
- Low fluid shear
- Module can be heated

pump size	chamber capacity	resolution*
B	400µl	0.04µl
C	1000µl	0.1µl
D	2000µl	0.2µl



Macro Linear Pump Module

This Pump Module can be used with the following module:

- Linear Actuator Module

## MACRO LINEAR PUMP MODULE

### Macro Linear Pump Module:

032106 - # # ###

**Case Type**

- 1 - w/out Heater Option
- 2 - w/ Heater Option

**O-Ring Material (static head seal)**

- 1 - Buna-N
- 2 - Ethylene Propylene
- 3 - Kalrez
- 4 - Polyurethane
- 5 - Silicone
- 6 - Teflon
- 7 - Teflon Encapsulated Silicone
- 8 - Viton

**Ceramic Size and Material**

- 007 - B, Alumina
- 008 - B, Zirconia
- 009 - C, Alumina
- 010 - C, Zirconia
- 011 - D, Alumina
- 012 - D, Zirconia
- 107 - B, Alumina, w/ Gland
- 108 - B, Zirconia, w/ Gland
- 109 - C, Alumina, w/ Gland
- 110 - C, Zirconia, w/ Gland
- 111 - D, Alumina, w/ Gland
- 112 - D, Zirconia, w/ Gland

## SF & LF MULTIPLEX PUMP MODULE

The Small Frame (SF) Multiplex Pump Modules incorporate a ceramic valve, piston and cylinder set housed within a polypropylene case. The Large Frame (LF) Multiplex Pump Modules incorporate a ceramic valve, piston and cylinder set housed within a stainless steel case. The SF and LF Pump Modules are both designed for quick, tool-free installation onto the Actuator Module and are constructed to withstand routine autoclaving and sterilization procedures.

### Features:

- 3-piece ceramic valve/piston/cylinder pump module design
- Pulse-free linear dispense profile
- Interchangeable pump modules
- Chemically inert wetted components
- Quick, tool-free installation & removal of pump modules
- Autoclavable wetted components

MULTIPLEX SYSTEM		
PUMP SIZE	CHAMBER CAPACITY	RESOLUTION*
200	200µl	0.005µl
400	400µl	0.01µl
2000	2000µl	0.05µl
4000	4000µl	0.1µl
5000	5000µl	0.125µl



SF Multiplex Pump Module



LF Multiplex Pump Module

These Pump Modules can be used with the following module:

- Multiplex Actuator Module



## SF & LF MULTIPLEX PUMP MODULE

### SF Multiplex Pump Module:

202304 -      #####      #      #

**Pump Size**

- 20N - 200µl, w/out Lip Seal C'Bore, Peek Washer, Ø6.15
- 20S - 200µl, with Lip Seal C'Bore, Peek Washer, Ø6.15
- 40N - 400µl, w/out Lip Seal C'Bore, Peek Washer, Ø8.00
- 40S - 400µl, with Lip Seal C'Bore, Peek Washer, Ø8.00

**Lip Seal**

- 0 - without
- 2 - 4.22mm Dia. Spring Energized
- 4 - 6.07mm Dia. Spring Energized

**Port Size**

- 1 - 1/4-28
- 2 - 5/16-24

### LF Multiplex Pump Module:

202122 -      #####      #      #

**Pump Size**

- 2000N - 2000µl, w/out Lip Seal C'Bore, Peek Washer, Ø10.2
- 2000S - 2000µl, with Lip Seal C'Bore, Peek Washer, Ø10.2
- 4000N - 4000µl, w/out Lip Seal C'Bore, Peek Washer, Ø14.35
- 4000S - 4000µl, with Lip Seal C'Bore, Peek Washer, Ø14.35
- 5000N - 5000µl, w/out Lip seal C'Bore, Peek Washer, Ø16.85
- 5000S - 5000µl, with Lip Seal C'Bore, Peek Washer, Ø16.85

**Lip Seal**

- 0 - without
- 2 - 9.75mm Dia. Spring Energized
- 4 - 13.92mm Dia. Spring Energized
- 5 - 15.76mm Dia. Spring Energized

**Threaded Sleeve**

- 1 - Castellated
- 2 - Knurled

## MICROSPENSE® AP MOTOR BASE MODULE

The MicroSpense® AP Motor/Base Module is comprised of the motor to drive a Micro Rotary Pump Module, the base to support the Auto Position/Auto Prime displacement adjustment mechanism and a cable with connector to interface with a Single Channel Rotary Controller or Multiple Channel Rotary Controller. This module is uniquely designed to minimize operator adjustment. An Auto Prime feature is built into the displacement head that allows the pump to be opened to full displacement for prime, cleaning or empty modes and then returned to a preset displacement for dispensing or metering. This adjustment can be accomplished manually or activated automatically. The MicroSpense® AP Motor/Base Module also includes a patented adjustment to optimize the ejection of drops as small as one microliter. The MicroSpense® AP Motor/base Module is available in single-ended (driving one pump) and dual-ended (driving two pumps) versions.

### Features:

- Repeatability to 0.1% CV
- Two position volumetric adjustment
- Automatic or manual adjustment for priming
- Compact & lightweight pump/motor/base module
- Displacement range of 0-109 $\mu$ l/stroke with low dead volume
- Versatile mounting capabilities including optional panel mount
- Capable of ejecting liquid volumes as low as 0.30 $\mu$ l
- Self-priming
- Low liquid shear
- Forward and reverse flow
- Clean in place capabilities

This Motor/Base Module can be used with the following modules:

- DigiSpense® 4000 Controller Module
- DigiSpense® 3009 Controller Module
- MultiSpense® 900 Controller Module
- Micro Rotary Pump Module
- Micro SR Pump Module



MicroSpense® AP Single End Motor/Base with Pump



MicroSpense® AP Dual End Motor/Base with Pump

## MICROSPENSE® AP MOTOR BASE MODULE

**Single-End MicroSpense® AP Motor Base Module:** 102118 - # # # 0

**Motor**

- 2 - Rare Earth Unipolar
- 3 - DC Brushless
- 4 - High Torque Unipolar
- 5 - High Torque Bipolar

**Flag Orientation**

- 1 - Standard
- 2 - 120° CCW

**Displacement Adjust Mechanism**

- 0 - None
- 1 - Standard
- 2 - w/ Micrometer
- 3 - w/ Digital Micrometer

**Double-End MicroSpense® AP Motor Base Module:** 102144 - # # # #

**Motor**

- 2 - Rare Earth Unipolar
- 3 - DC Brushless
- 4 - High Torque Unipolar
- 5 - High Torque Bipolar

**Flag Position**

- 1 - Standard
- 2 - 120° CCW

**Displacement Adjust Mechanism**

- 0 - None
- 1 - Standard
- 2 - w/ Micrometer
- 4 - w/ Digital Micrometer

**Dispense Mode**

- 1 - Alternating
- 2 - Simultaneous

**Double-End Rotary Adjust MicroSpense® AP Motor Base 102006 - # # # #**

**Motor**

- 2 - Rare Earth Unipolar
- 3 - DC Brushless
- 4 - High Torque Unipolar
- 5 - High Torque Bipolar

**Positive Stop Tab**

- 1 - Without
- 2 - With

**Cover Plate**

- 1 - Side Entry
- 2 - Rear Entry

**Cable**

- 1 - 8Ft Standard
- 2 - 8Ft Flange
- 3 - 1Ft Metal Flange

## MICROSPENSE® AP MOTOR BASE MODULE

**Panel Mount MicroSpense® AP Motor/Base Module: 102150 - # # # ##**

<b>Motor Type/Panel Thickness</b>	#	#	#	##
2 - Rare Earth Stepper Motor				
3 - DC Brushless Motor				
4 - High Torque Unipolar Stepper				
5 - High Torque Bipolar Stepper				
<b>Panel Thickness</b>				
1 - 14 GA				
2 - 16 GA				
3 - 18 GA				
4 - 12 GA				
<b>Flag Position</b>				
1 - Standard				
2 - 120 CCW				
3 - 120 CW				
4 - 60 CW				
<b>Pigtail Length in Centimeters</b>				
20 - 20cm Standard				
30 - 30cm Maximum				

**Single-End Rotary Adjust MicroSpense® AP Motor Base 102009 - # # # #**

<b>Motor</b>	#	#	#	#
2 - Rare Earth Unipolar				
3 - Brushless DC				
4 - High Torque Unipolar				
5 - High Torque Bipolar				
<b>Positive Stop Tab</b>				
1 - Without				
2 - With				
<b>Cover Plate</b>				
1 - Side Entry				
2 - Rear Entry				
<b>Cable</b>				
1 - 8Ft Standard				
2 - 8Ft Flange				
3 - 1Ft Metal				

## HEAVY DUTY MOTOR BASE

The Heavy Duty Motor/Base Module is comprised of a motor to drive the Split Case Rotary Pump Module, the base to support the displacement adjustment mechanism and a connector to interface with a Single Channel Rotary Controller or Multiple Channel Rotary Controller. Each motor is specifically chosen to optimize the speed and torque appropriate for each application. The Base assembly attached to the motor is 316 stainless steel and includes a displacement adjustment mechanism that can be locked in place once set. A unique feature in the design of the adjustment mechanism permits Split Case Pump Module removal and replacement without altering the calibrated setting. An optional Dial Indicator can be mounted on each base assembly for fine measurement of setting. The Motor/Base module will provide millions of maintenance free cycles and is available in single-ended (driving one pump) and dual-ended (driving two pumps) versions.

### Features:

- 316 stainless steel swing plate for displacement adjustment
- Capable of locking to a fixed displacement
- Rugged design
- 34 frame stepper motor standard (1,2,3 stack available)
- Fluidically optimized acceleration & deceleration
- High speed motors available
- Non-sparking – no brushes or commutators
- Dial Indicator Calibration Gauge, optional
- Built in mounting holes
- Swing plate allows easy Split Case Pump Module removal
- Interchangeable pump modules
- Fluidic Pulse Dampener option available

This Motor/Base Module can be used with the following modules:

- DigiSpense® 4000 Controller Module
- DigiSpense® 3009 Controller Module
- MultiSpense® 900 Controller Module
- Heavy Duty Plus (HD+) Pump Module
- Split Case Pump Module



Single Ended Heavy Duty Motor/Base Module  
w/ Split Case Pump Module



Double Ended Heavy Duty Motor/Base Module  
w/ Split Case Pump Modules

## HEAVY DUTY MOTOR BASE

Single-Ended Heavy Duty Motor/Base Module: 092117 - # # # #

**Pulse Dampener**

- 0 - None

**Calibration Gauge**

- 0 - Thumbwheel Adjust w/ No Gauge
- 1 - Thumbwheel Adjust w/ Analog Gauge
- 2 - Micrometer Adjust w/ Digital Gauge
- 3 - Micrometer Adjust w/ no Gauge
- 4 - Thumbwheel Adjust w/ Digital Gauge

**Motor**

- 2 - Double Stack, Unipolar Stepper
- 3 - Triple Stack, Unipolar Stepper
- 4 - Brushless DC
- 5 - High Torque, Bipolar Stepper

**Flag Orientation**

- 0 - Standard
- 1 - 120° CCW

Double-Ended Heavy Duty Motor/Base Module: 092128 - # # # # #

**Pulse Dampener**

- 0 - None

**Calibration / Gauge / Micrometer Adjust**

- 0 - Thumbwheel Adjust w/ No Gauges
- 2 - Thumbwheel Adjust w/ Analog Gauges
- 5 - Micrometer Adjust w/ Digital Gauges
- 7 - Micrometer Adjust w/ No Gauges
- 8 - Thumbwheel Adjust w/ No Gauges

**Motor Size**

- 2 - Double Stack, Unipolar Stepper
- 3 - Triple Stack, Unipolar Stepper
- 4 - Brushless DC
- 5 - High Torque, Bipolar Stepper

**Dispense Mode**

- 1 - Stainless Bearing, Alternating
- 2 - Stainless Bearing, Simultaneous
- 3 - Bronze Bearing, Alternating
- 4 - Bronze Bearing, Simultaneous

**Flag Orientation**

- 0 - Standard
- 1 - 120° CCW

## MEGASPENSE®

IVEK is pleased to introduce the new MegaSpense®, our largest displacement pump offering. The MegaSpense® pump module is unique among positive displacement rotary and reciprocating piston pumps. It is designed to allow disassembly of all the pump module components and/or the removal and return of the entire pump module from the motor/base group without recalibration. The break down of all the wetted components enhances cleaning and the module can be autoclaved. All aspects of a 'user friendly' design and customer suggestions were considered during the pump module's development in order to allow fluid to flow freely, unobstructed through the wetted components without exposure to dead volume areas such as cracks, crevices, or threads. This heavy-duty pump module is extremely durable and stable, and will maintain calibration and accuracy during even the most difficult applications.

### Features:

- Quick disassembly
- Stainless Steel or Aluminum motor/base & pump options available
- Stroke length calibration is retained after disassembly
- Ceramics can be autoclaved independently
- Easily replaceable high performance Teflon or custom seals
- Easily interchangeable components
- Self-priming
- Cleaning commonly accomplished through flushing procedure (CIP)
- High purity Alumina
- Pump sizes: up to 15ml/stroke
- Capable of up to 5L/minute
- Custom modifications available
- Optional lip/face seal available for increased sealing
- Optional gland port available for fluid recirculation
- Laser-etched serial numbers on each part
- Piston/cylinder sets are matched
- Custom fittings available on request
- Easy assembly/disassembly
- Variety of nozzles available
- Standard materials: stainless
- Sanitary, chemically resistant design

This Motor/Base Module can be used with

- DigiSpense® 4000 Controller Module
- DigiSpense® 3009 Controller Module



Single End MegaSpense® 44.4cm x 21.4cm x 20.6cm



Dual End MegaSpense® 68.2cm x 24cm x 20.6cm



Close-up MegaSpense® Pump Module

## MEGASPENSE

### Single-End MegaSpense® Motor/Base Module:

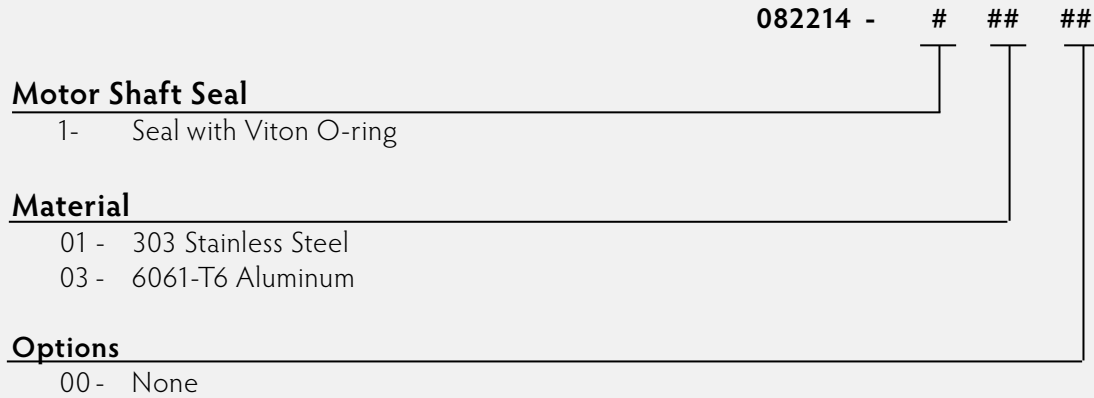

### Double-Ended MegaSpense® Motor/Base Module:

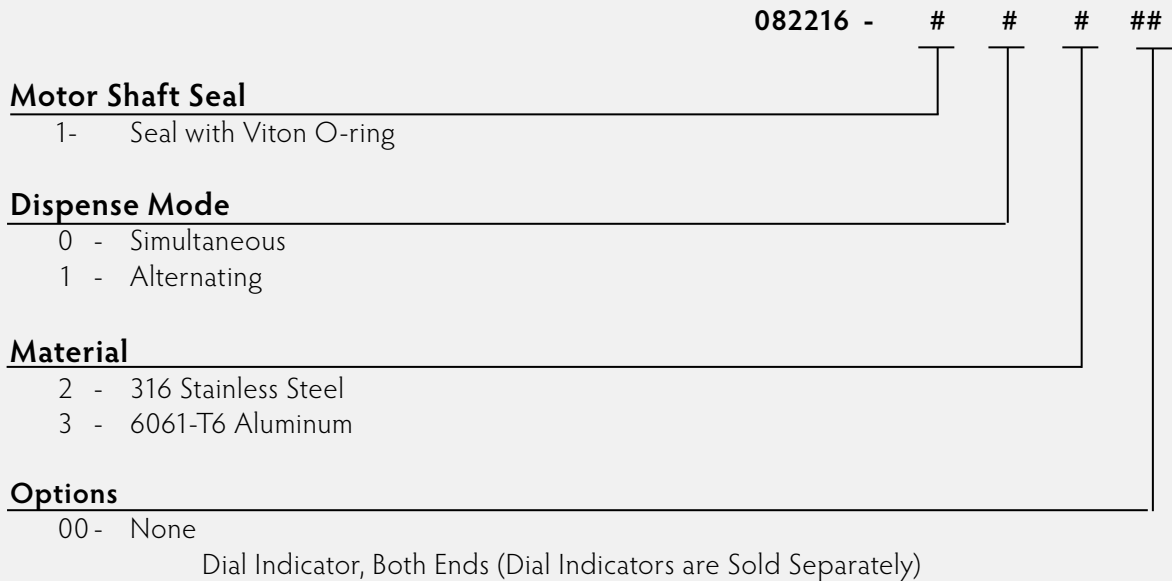



## MICRO & MACRO LINEAR ACTUATORS

The patented 2000 Series Linear Actuator Module is comprised of a motor and leadscrew to drive the Micro/Macro Linear Pump Module, and a connector to interface with a Single Channel Linear Controller or Multiple Channel Linear Controller. Linear motion provides the function of filling the pump chamber with fluid and incrementally displacing fluid from the chamber. Rotary motion provides selective valving of the piston to either the fluid intake port or discharge port. Integral to the Actuator Module is an electromagnetic clutch/brake mechanism and lead screw (either 20-pitch or 40-pitch). The 20-pitch Actuator Module is used with Macro Linear Pump Modules (B, C and D sizes) and the 40-pitch Actuator Module is used with Micro Linear Pump Modules (A, 2A, 3A and 4A sizes).

### Features:

- Digital volumetric adjustment
- Pulse-free linear motion (fluid flow profile)
- 20-pitch or 40-pitch models available
- Four input/output port positions available
- Interchangeable pump modules
- Non-sparking – no brushes or commutators



20-Pitch Actuator Module



40-Pitch Actuator Module



20-Pitch Actuator Module  
w/ mounting plate



40-Pitch Actuator Module  
w/ mounting plate

These Actuator Modules can be used with the following modules:

- DigiSpense® 4000 Controller Module
- DigiSpense® 3020 Controller Module
- MultiSpense® 2000 Controller
- Macro Linear Pump Module
- Micro Linear Pump Module

## MICRO & MACRO LINEAR ACTUATORS

### 20-Pitch Linear Actuator Module:

032038 - ## # # #

**Dispense Port Position**

- 03 - 3 O’Clock
- 06 - 6 O’Clock
- 09 - 9 O’Clock
- 12 - 12 O’Clock

**Encoder**

- 1 - w/out Encoder, Discrete Sensors
- 2 - w/ Encoder

**Sensor**

- 2 - Optical Linear

**Coupler**

- 1 - Standard
- 2 - Heavy Duty
- 3 - A- Size Pumps

### 40-Pitch Linear Actuator Module:

032037 - ## # # #

**Dispense Port Position**

- 03 - 3 O’Clock
- 06 - 6 O’Clock
- 09 - 9 O’Clock
- 12 - 12 O’Clock

**Encoder**

- 1 - w/out Encoder, Discrete Sensors
- 2 - w/ Encoder, Discrete Sensors

**Sensor**

- 2 - Optical Linear

**Coupler**

- 1 - Standard

## MICRO & MACRO PANEL MOUNT LINEAR ACTUATORS

### 20 & 40 Pitch Panel Mount Linear Actuator Modules:

032241 - # # # # #

**Actuator**

- 5 - 40 Pitch Actuator No Encoder
- 6 - 40 Pitch Actuator w/ Encoder
- 7 - 20 Pitch Actuator No Encoder
- 8 - 20 Pitch Actuator w/ Encoder

**Panel Mount Material**

- 1 - Aluminum Housing, Flange & Ring - Panel Mount Assy
- 2 - Stainless Steel Housing, Flange & Ring - Panel Mount Assy
- 3 - Aluminum Housing, Stainless Steel Adaptor Ring, Aluminum Mounting Flange
- 4 - Aluminum Housing, Stainless Steel Adaptor Ring & Mounting Flange

**Coupler**

- 1 - Heavy Duty Coupler (20-Pitch Only)
- 2 - Size 34 Coupler (20-Pitch Only)
- 3 - Size 27 Coupler (40-Pitch Only)

**Dispense Port Position**

- 12 - 12 O'Clock
- 09 - 9 O'Clock
- 06 - 6 O'Clock
- 03 - 3 O'Clock

**Gasket Material**

- 0 - w/out Gasket
- 1 - Buna-N
- 2 - EPDM
- 3 - Polyurethane
- 4 - Silicone
- 5 - Fluoroelastomer

## MULTIPLEX ACTUATOR

The Multiplex Actuator Module is a multi-channel unit containing the drive and fixturing components for the Multiplex Pump Modules. Two models are available, small frame (SF) or large frame (LF), and may be configured for either 8, 10 or 12 channels. The Actuator Module imparts rotary and linear motion to the Pump Modules as commanded by the Multiplex Controller Module. Pneumatic actuators impart rotary motion for valving to intake or discharge ports. Servo motor driven lead screws provide linear motion to the Pump Modules for fluid intake and discharge. The Multiplex Actuator Module is designed for quick, tool-free installation and removal of the Pump Modules.

### Features:

- Utilizes a high resolution servo motor (resolution of 40,000 increments)
- Servo motor produces precisely controlled linear motion for fluid intake/discharge
- Pneumatic actuators produce rotary motion for valving
- 3-piece ceramic valve/piston/cylinder pump module design
- Pulse-free linear dispense profile
- Interchangeable pump modules
- Chemically inert wetted components
- Quick, tool-free installation & removal of pump modules
- Autoclavable wetted components



Small Frame 8 Channel Multiplex Actuator



Large Frame 12 Channel Multiplex Actuator

These Actuator Modules can be used with the following modules:

- Multiplex Controller Module
- SF & LF Multiplex Pump Modules

## MULTIPLEX ACTUATOR

### Small Frame (SF) Multiplex Actuator:

SF12 - Channel Multiplex	202392
SF10 - Channel Multiplex	202393
SF8 - Channel Multiplex	202394

### Large Frame (LF) Multiplex Actuator:

LF12 - Channel Multiplex	202395
LF10 - Channel Multiplex	202396
LF8 - Channel Multiplex	202397

## SINGLE CHANNEL DISPENSING SYSTEMS

**ELECTROSPENSE®**

IVEK Corporation's new ElectroSpense® pump offers outstanding accuracy and convenience for your dispensing requirements. The ElectroSpense® combines the proven performance of IVEK's AP pump head and precision machined, ceramic pumps, with a MicroSpense® Integrated Controller packaged inside the motor. This Integrated Controller saves space and eliminates the traditional cable and separate electronic enclosure. The ElectroSpense® pump parameters are generated by IVEK's application team for your unique dispensing requirements. Once these parameters are optimized for fluidic performance, a program is developed and downloaded onto the integrated controller. A 24 VDC power source and a process signal are the only requirements for a simple, trouble free installation. The ElectroSpense® can dispense 1µL through 5 mL with maximum flow rates of 4L/min. IVEK's new ElectroSpense® pump is a reliable, accurate and economical solution for many applications, including: single and multiple channel dispensing, OEM applications, spraying applications and more.

**Features:**

- Repeatability to 0.1% CV
- Compact & lightweight pump/motor/base module
- Displacement range of 0-5ml/stroke with low dead volume
- Versatile mounting capabilities
- Low liquid shear
- Forward & reverse flow
- Clean in place capabilities
- Dispense or meter operating modes
- Highly integrated microstepping drive
- Advance current control for exceptional performance & smoothness
- Closed loop control
- Incremental drawback & selectable stopping position for high viscosity fluids
- Custom set parameters
- CE certified
- One-year warranty



ElectroSpense® 7cm x 12cm x 16cm



ElectroSpense® Close-Up Pump Module



ElectroSpense® 7cm x 12cm x 16cm

SINGLE CHANNEL DISPENSING SYSTEMS

### ELECTROSPENSE®

**ElectroSpense® 23 Frame, Single End:**

102274- ## ##

**Motor Base**

- 01 - Displacement Adjust
- 03 - w/ Micrometer

**Motor Stack/IP Rating**

- 11 - One Stack, RS422/RS485
- 12 - One Stack, M12 IP65

**ElectroSpense® 34 Fame, Single End:**

092320- # # # #

**Calibration Gauge**

- 0 - No Calibration Gauge
- 1 - Calibration Gauge

**Motor Stack**

- 1 - Single Stack

**Base Material**

- 1 - Stainless Steel

**Communication**

- 1 - RS422/RS485

These Actuator Modules can be used with the following modules:

- Micro Rotary Pump Module
- Micro SR Pump Module
- Split Case Pump Module
- Heavy Duty Plus (HD+) Pump Module

## SINGLE CHANNEL DISPENSING SYSTEMS

**DIGISPENSE® 3009**

A high precision liquid dispensing system, the DigiSpense® 3009 consists of an electronic controller module operating a stepper motor that can drive the motor/base with one or two precision, ceramic, rotary/reciprocating, liquid dispensing pump modules. The DigiSpense® 3009 system operates all IVEK 23 and 34 frame stepper motor/base and pump modules designed to handle discrete dosing from 0.1ul and higher.

IVEK's DigiSpense® 3009 system is designed for flexibility in system integration. 24V logic I/O for PLC interfacing, RS232 interfaces and contact closure trigger are standard features. A non-volatile memory allows storage of 32 parameter configurations. The system is compact in design and requires no line voltage selection. All these features make the DigiSpense® 3009 the most versatile precision single-channel dispensing system available.

Standard features of IVEK's DigiSpense® 3009 controller module include: Contact Closure trigger input, Auxiliary Output, 24VDC Logic interface (for trigger-in, ready-out, fault-out, 3 user selectable inputs, and 2 user selectable outputs) and an RS232 interface.

**Features:**

- Dispense & meter operating modes
- Rate controllable from 1 to 1,500 RPM
- Volume selection to 10,000 strokes per dispense trigger
- Selectable acceleration profile
- Prime mode
- Forward/reverse modes
- Selectable motor torque
- Non-volatile memory (NVRAM) for storage of parameters & up to 32 recipes
- Incremental drawback & selectable stopping position for high viscosity fluids
- Password-protected permission levels assure no unwanted parameter changes
- Transferable from bench top use to full system integration/automation
- 24V optically isolated interface for PLC integration
- RS232 interface
- Contact closure trigger
- CE certified
- TÜV listed



DigiSpense® 3009 Controller Module

This Controller Module can be used with the following modules:

- MicroSpense® AP Motor/Base Module
- Heavy Duty Motor/Base Module
- MegaSpense® Motor/Base Module



## DIGISPENSE® 3009

### DigiSpense® 3009 Controller Module:

520235 - # # # # #

**Motor/Base**

B - 1500 RPM (48VDC @ 5A)

**Logic Interface**

B - Trigger In (CC), PLC (OI)

**Parameter Interface**

B - RS232, RS485, USB

**Front Panel**

B - Membrane Sw, LCD w/LED Back Light

**Line Cord/CE**

C - North American, TÜV Certified

D - International, TÜV Certified

OI = Optically Isolated  
CC = Contact Closure

### Cable Assemblies (#'s specify length of cable in decimeters):

540242 - #### = meters, 10m max for unipolar MicroSpense® motorbases

540243 - #### = meters, 10m max for unipolar Heavy-duty motorbases

540265 - #### = meters, 10m max for bipolar MicroSpense®, Heavy-duty & MegaSpense® motorbases

## SINGLE CHANNEL DISPENSING SYSTEMS

**DIGISPENSE® 3020**

The DigiSpense® 3020 controller is a component in IVEK's low volume, linear flow, single-channel, liquid dispensing system. The system includes three main components; a 3020 Controller module, a 20- or 40-pitch Linear Actuator Module and one of seven positive displacement ceramic pump modules. A major feature of this system is the programmed dispense volume which does not require mechanical calibration. The DigiSpense® 3020 controls each full stroke of the piston to an exceptional resolution of 10,000 increments. Operating parameter controls offer separate dispense/meter and prime/load mode rates, forward/reverse, and drawback control.

The controller provides flexible operation and an efficient user interface. It includes two top-level modes of operation; (1) Fluidic Setup Mode with Prime, Bubble Clear and Agitate functions; (2) Production Mode with Dispense, Dispense Minimum Chamber Volume, Meter, Dispense Multichamber, and Meter Multichamber functions. The system can be configured to automatically load on every dispense, when the chamber is empty, or load manually.

Standard features of IVEK's DigiSpense® 3020 controller module include: Contact Closure trigger input, Auxiliary Output, 24VDC Logic interface (for trigger-in, ready-out, fault-out, 3 user selectable inputs, and 2 user selectable outputs) and an RS232 interface. A non-volatile memory allows storage of up to 32 dispense parameter recipes.

**Features:**

- Electronic volume select
- Programmable operating modes
- Resolution of 10,000 increments
- Superior linear flow profile
- Non-volatile memory for storage of parameters & up to 32 recipes
- Programmable drawback
- Accepts closed-contact trigger input, 24VDC logic interface & RS232 serial communication
- Password-protected permission levels
- Encoder option
- Auto line voltage selection (100 to 240VAC, 50/60Hz)
- Transferable from benchtop use to fully integrated systems
- CE certified
- TÜV listed



DigiSpense® 3020 Controller Module

This Controller Module can be used with the following module:

- Linear Actuator Module

## DIGISPENSE® 3020

### DigiSpense® 3020 Controller Module:

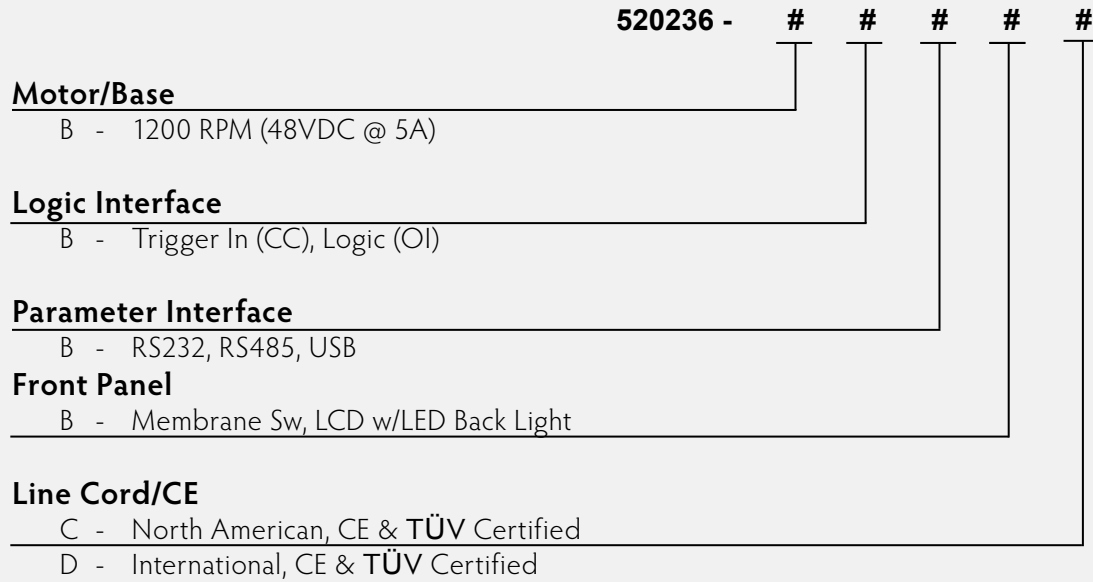

OI = Optically Isolated  
CC = Contact Closure

### Cable Assemblies (#'s specify length of cable in decimeters):

540241 - ### = meters, 10m max for Actuators without encoder

540238 - ### = meters, 10m max for Acutators with encoder

## DIGISPENSE® 4000

The DigiSpense® 4000 is IVEK's latest, high-performance, production oriented, single-channel dispensing system combining both Rotary and Linear functionality into one package. The DigiSpense® 4000 enables precise and repeatable fluid dispensing volumes at rates of 2nl per second to 300 mL per second. Dynamic microstepping technology significantly improves pump performance at low dispense rates. Production modes, including Dispense, Meter and Feeder, offer unique dispensing profiles for a wide range of applications. Fluidic Setup modes, including Prime, Agitate and Bubble Clear, prepare the fluid path for reliable, repeatable dispensing and reduced maintenance.

The DigiSpense® 4000 controller is simple to operate out of the box. Parameter configuration screens allow for easy creation of unique dispensing profiles. Improved integration to PLC control systems, facilitated by Ethernet fieldbus communication options and web browser services, reduces development time and cost.

### Panel Mount Model

The DigiSpense® 4000's panel mount compact footprint, along with minimal side-to-side clearances, allows multiple controllers to fit into a dedicated cabinet, or to be combined with other control equipment in an existing cabinet. Terminal block style connectors allow the cables to be passed through conduits during installation, while maintaining quick-disconnection. Two Ethernet ports enable the fieldbus to be wired in either a star or ring topology. Multi-color LEDs provide the user with local feedback of the status of the network, dispensing state, and power supply.

### Benchtop Model

The DigiSpense® 4000 Benchtop controller has all of the dispensing features listed above but with a fully enclosed power supply and HMI for benchtop or stand-alone use. A front-panel LCD screen with pushbuttons allows full configuration of dispensing profiles and start/stop of dispensing operations. Contact-closure IO on the rear panel provides both control and status of dispensing operations using such devices as foot pedals and totalizers/counters. Optional Ethernet field bus communications for data acquisition or PLC integration is available.



The DigiSpense® 4000's panel mount compact footprint, along with minimal side-to-side clearances, allows multiple controllers to fit into a dedicated cabinet, or to be combined with other control equipment in an existing cabinet.

These Controller Modules can be used with the following:

- Linear Actuator Modules
- Rotary Pumps

## DIGISPENSE® 4000

### FEATURES AND BENEFITS

- Production modes: Dispense, Meter, Feeder, Maintainer
- Fluidic setup modes: Prime, Agitate, Bubble Clear, Prime Reverse
- Volume units: nanoliters (nl), microliters (µl), milliliters (ml)
- Configurable drawback to enhance fluidic sheering at tip
- Recipe storage of up to 32 dispensing profiles
- Password protected permission levels to limit operator access to dispensing profile
- EtherNet/IP™ and ODVA Conformance™
- EtherCAT®
- CE certified
- One year warranty

### PANEL MOUNT CONTROLLER FEATURES

- Compact footprint for mounting multiple controllers into a cabinet
- Flexible 24-48VDC input power, filtered and reverse polarity protected
- Multi-color LEDs for quick identification of status

### BENCH TOP CONTROLLER FEATURES

- Compact Benchtop-friendly enclosure with adjustable bail and non-slip feet
- LCD Display and operator interface
- 4-20mA analog inputs/outputs
- Configurable PLC IO points
- Configurable contact closure inputs and high current auxiliary outputs
- Integrated Liquid Eye capability
- Isolated 24VDC 1.5A power supply for customer use
- Universal AC power supply 100-240VAC 50/60Hz
- Optional fieldbus EtherNet/IP™, EtherCAT®, RS232, USB
- TÜV listed



DigiSpense® 4000 panel mount controller module  
7.62cm W x 14.34cm D x 19cm H



DigiSpense® 4000 bench top controller module  
21cm x 29.2cm x 14.6cm

## DIGISPENSE® 4000 PANEL MOUNT

### DigiSpense® 4000PM Controller Module:

520269 - # # # # #

**Drive Interface**

A - 1500 RPM (24-28VDC @5A)

**Logic I/O**

A - No I/O

**Fieldbus Module**

- A - EtherNet/IP™, No Bootloader
- B - EtherNet/IP™, w/Bootloader
- E - EtherCAT®, w/Bootloader

**Enclosure**

A - Standard Steel, Grey/White

**Connectors**

A - North American, CE

## DIGISPENSE® 4000 BENCH TOP

### DigiSpense® 4000BT Controller Module:

520274 - # # # # #

**Drive Interface**

A - 1500 RPM (48VDC @5A)

**Logic I/O**

A - Contact Closures, Aux. Inputs/Outputs, Analog Input/Output, Liquid Eye, Characteristics 01

**Fieldbus Module**

- A - No Fieldbus Module
- B - Ethernet/IP
- C - RS232
- D - USB
- E - EtherCAT®

**Front Panel**

A - Standard Front Panel, Membrane Switch Panel, Monochrome LCD w/ Backlight

**Power Cord**

- A - North American, CE
- B - International, CE

## MULTIPLE CHANNEL DISPENSING SYSTEMS

**MULTISPENSE®**

IVEK offers a series of MultiSpense® systems that are designed to dispense precise fluid volumes in a multiple channel configuration. MultiSpense® systems can be custom configured, thereby providing capability for as many as 31 dispensing channels from one controller module. Additional controllers can be interfaced to provide as many channels or pumps as needed. Typical dosing volumes range from sub-microliter to several milliliters. Each multiple channel system is custom manufactured to meet specific application requirements.

IVEK'S MultiSpense® 900 and 2000 series controllers include easily accessible Eurocard channel boards and standard RS232 interface ports for programming operating parameters by a user-supplied computer. All MultiSpense® 900 and 2000 controllers include a system PLC interface to accept Trigger Input and return Ready Output and Fault Output signals, optimizing their integration onto modern production lines. Optional PLC Independent Channel Trigger Input and Channel Ready/Fault Output provide the flexibility of individual channel control.

The MultiSpense® 900 and 2000 series controllers offer an optional remote Touchscreen operator interface whereby all MultiSpense® operating parameters are set and monitored through the Touchscreen. Also provided are three levels of permission (Operator, Manual and Supervisor) and ability to save/retrieve 25 recipes.

The MultiSpense® 2000 w/Microstep provides five times the resolution of the standard MultiSpense® 2000 Controller Module.

**Features:**

- Single controller with single or multiple channel capability
- Retains high reliability, accuracy & low maintenance attributes
- Engineered for integration with other production equipment
- All channels linked through central logic
- Modular circuit boards for easy access
- Individual Channel Disable
- Individual Channel Trigger Input and Ready/Fault Output (optional)
- System PLC interface
- Totalizing of cycles/dispenses
- Prime, meter & dispense modes
- Pump forward & reverse modes
- Pump drawback mode
- Drawback dwell adjustments
- RS232 Interface or Touchscreen Interface
- 25 configuration default memory (Touchscreen Only)
- Three levels of password protection (Touchscreen Only)
- CE certificate available



MultiSpense® 2000

The MultiSpense® 900 Controller Module can be used with the following modules:

- MicroSpense® AP Motor/Base Module
- Heavy Duty Motor/Base Module

The MultiSpense® 2000 Controller Module can be used with the following modules:

- Linear Actuator Module

**MULTISPENSE®**

**MultiSpense® 900:**

1 - 2 Channel 520254 -	#	##	#	#	#	#
3 - 4 Channel 520251 -	#	##	#	#	#	#
5 - 8 Channel 520246 -	#	##	#	#	#	#
9 - 16 Channel 520240 -	#	##	#	#	#	#
17 - 24 Channel 520243 -	#	##	#	#	#	#

**Motor/Base**

- C - MicroSpense® AP, Rare Earth Motor
- D - MicroSpense® AP, Custom Overdrive
- E - Heavy Duty, 1 Stack
- F - Heavy Duty, 2 Stack
- G - Heavy Duty, 3 Stack
- H - Heavy Duty, Custom Overdrive

**Number of Installed Channels**

- 00 - 24 (per enclosure)

**Motor Voltage**

- A - 2.5V Low, 90V High (For all Motor/Base options except G)
- B - 5.0V Low, 90V High (For Motor/Base option G - Heavy Duty, 3 Stack)

**Logic Interface**

- L - PLC w/Load Input, Independent Trigger In, Independent Ready Out Contact Closure

**Parameter Interface**

- H - Local Terminal
- I - Remote Terminal

**Line Cord & Agency Approval**

- C - North American, 115/120 VAC & CE
- D - International, 115/120 VAC & CE
- G - North American, 230/240 VAC & CE
- H - International, 230/240 VAC & CE
- I - North American, 100 VAC & CE
- J - International, 100 VAC & CE
- K - North American, 200/208 VAC & CE (not available on 1-4 channel systems)
- L - International, 200/208 VAC & CE (not available on 1-4 channel systems)
- M - North American, 220 VAC & CE
- N - International, 220 VAC & CE



## MULTISPENSE®

### MultiSpense® 2000:

<b>1 - 2 Channel 520255</b>	-	#	##	#	#	#	#
<b>3 - 4 Channel 520252</b>	-	#	##	#	#	#	#
<b>5 - 8 Channel 520247</b>	-	#	##	#	#	#	#
<b>9 - 16 Channel 520241</b>	-	#	##	#	#	#	#
<b>17 - 24 Channel 520244</b>	-	#	##	#	#	#	#

#### Actuator/Encoder

- |                          |                                     |
|--------------------------|-------------------------------------|
| A - 40 Pitch, No Encoder | J - 20 Pitch, No Encoder, A-20 Pump |
| B - 40 Pitch, Encoder    | K - 20 Pitch, Encoder, A-20 Pump    |
| E - 20 Pitch, No Encoder |                                     |
| F - 20 Pitch, Encoder    |                                     |

#### Number of Installed Channels

- 00 - 24 (per Enclosure)

#### Motor Voltage

- A - 2.5V Low, 90V High

#### Logic Interface

- L - PLC w/Load Input, Independent Trigger In, Independent Ready Out Contact Closure

#### Parameter Interface

- H - Local Terminal
- I - Remote Terminal

#### Line Cord & Agency Approval

- C - North American, 115/120 VAC & CE
- D - International, 115/120 VAC & CE
- G - North American, 230/240 VAC & CE
- H - International, 230/240 VAC & CE
- I - North American, 100 VAC & CE
- J - International, 100 VAC & CE
- K - North American, 200/208 VAC & CE (not available on 1-4 channel systems)
- L - International, 200/208 VAC & CE (not available on 1-4 channel systems)
- M - North American, 220 VAC & CE
- N - International, 220 VAC & CE

## MULTIPLEX V3

The Multiplex Controller Module is a multi-channel, microprocessor-based unit containing control, monitoring, and interface components for driving a precision Multiplex Actuator Module. Precise linear motion for fluid displacement and rotary motion for selective valving are commanded and monitored by the Multiplex Controller Module. Interface connections are located on the rear panel and include PLC interface, EtherNet/IP™ connectivity and RS232 computer interface. The Controller Module can be configured to operate 8, 10 or 12 channel Small or Large Frame Actuator modules. In combination with the Actuator/Pump Modules, the Multiplex Controller Module provides very accurate and precise fluid dispensing and metering requiring no mechanical displacement adjustments.

### Features:

- Multi-channel
- Drives one small or large frame 8, 10 or 12 channel Actuator Module
- PLC interface
- Touchscreen interface
- All operational parameters programmed through EtherNet/IP™ connectivity and RS232 interface (ASCII commands)
- Independent channel enable/disable
- CE certified



Multiplex V3 Controller

This Controller Module can be used with the following module:

- Multiplex Actuator Module

## MULTIPLEX V3

### Multiplex V3 Controller Module:

520225 - # # # # #

**Motor Drive**

- A - Servo, 3.6A
- B - Servo, 4.5A

**Logic Interface**

- A - PLC I/O

**Communications**

- A - RS232, EtherNet/IP™

**Front Panel**

- A - Touchscreen

**Line Cord/CE**

- A - North American, CE
- B - International, CE

## METHASPENSE® - CONTROLLED SUBSTANCE DISPENSING SYSTEM

The MethaSpense® Controlled Methadone Dispensing System has been specifically designed for computer-controlled use in drug addiction management clinics. IVEK Corporation has been manufacturing precision positive displacement dispensing systems specifically for use in these programs for over 20 years. The system is noted for reliability, low maintenance and high precision fluid handling. It is easy to operate but does not compromise accuracy. The system exhibits the same high accuracy, low maintenance, positive displacement IVEK ceramic pump modules that have proven to provide millions of wear-free cycles and years of performance. The MethaSpense® features a two-position bottle cradle to allow refilling the system without the loss of prime to the pump or transferring liquid from one bottle to another. This design minimizes fluid loss and enhances record keeping while providing a more sanitary diversion of fluid. The system includes a Liquid Eye bubble detector. An alarm alerts the operator of any air gaps in the fluid line that may compromise precision before a dose is dispensed. The MethaSpense® system is housed in a stainless steel case and can be easily moved and secured during non-operating hours. The system can accept a variety of bottle sizes and is easily integrated with patient management computer programs and includes an adjustable cup holder and a key-protected access to the supply bottle.

### Features:

- Controller and pump in one stainless steel case
- High-speed brushless DC motor and controller
- Whisper-quiet motor
- Featuring Positive Displacement Ceramic Pumps
- Easy integration to RS232 serial interface
- Precision volumetric flask for accuracy checks
- Factory calibrated motor/base pump module
- Patented 'zero-transfer' bottle holder
- Exclusive 'liquid eye' bubble detection
- Accepts a variety of bottle sizes
- Key lock security
- CE certified



MethaSpense®

### MethaSpense®:

132409 - ##

#### Voltage

- 01 - MicroSpense® AP, Single End MicroSpense® AP, Single End 100/120 VAC
- 02 - MicroSpense® AP, Single End MicroSpense® AP, Single End 220/240 VAC

## DIGISPENSE® 1000 - CONTROLLED SUBSTANCE DISPENSING SYSTEM

The IVEK DigiSpense® 1000 Methadone Dispenser is a precision, high speed, low volume, positive displacement liquid dispensing system capable of the industries' highest accuracy and repeatability. The wetted components include 99.8% pure Alumina ceramic piston/cylinder modules. These components are mated together to a clearance of 120 millionths of an inch. With only one moving part in the fluid path, systems have been operating for years without measurable wear. The dispenser is often used for dosing pharmaceuticals where inventory control and accuracy are critical.

An RS232 interface port on the controller module makes the system easy to link to computers. Several software companies have developed complete turnkey systems with networking capabilities to maintain patient records, prescription information, data acquisition and process validation. Many of these companies integrate the IVEK DigiSpense® 1000 Methadone Dispenser for the fluid dosing.

**Features:**

- High-speed brushless DC motor & controller
- Whisper-quiet motor
- Ceramic pump parts capable of millions of cycles without measurable wear
- Adjustable motor speed
- Easy to control from the RS232 interface
- Factory-made tubing kits with bottle cap connections
- Precision volumetric flask for accuracy checks
- Factory pre-calibrated motor/base pump module
- CE certified & TÜV listed



DigiSpense® 1000 controller w/ single end motor base module

**DigiSpense® 1000:**

520260 - # # # # #

**Motor**

A - 1800 RPM 48 VDC @3A

**Logic Interface**

A - None

**Communications**

A - RS232, USB

**Front Panel**

A - with LED's

**Line Cord**

- C - North American, TÜV Certified
- D - International, TÜV Certified

## CONTROLLED SUBSTANCE DISPENSING STATION - CSDS\*

The new Controlled Substance Dispensing Station is an all-in-one solution for addiction management clinics. A user friendly design that is portable, secure and easy to clean. Optional with both IVEK's DigiSpense® 10/RS232 and DigiSpense® 1000 systems.

### Features:

- Featuring IVEK's positive displacement ceramic pumps
- Precision volumetric flask for accuracy checks
- Factory pre-calibrated motor/base pump module
- Shorter tubing runs for faster priming & less waste
- Fixed dispense tip for no mess dosing
- Adjustable spill tray locations for varying cup sizes
- Lockable latches (locks not supplied)
- Sealed front cover allowing for up to 1L of fluid spill inside enclosure without leaks
- Zero-Transfer bottle holder & is compatible with all major medicine manufacturers
- Compatible with existing IVEK DigiSpense® 1000 System
- Free installation & calibration of existing pump with CSDS purchase
- CSDS with pump may be returned to IVEK for standard cleaning & calibration



NEW all-in-one portable, secure, easy clean, controlled substance dispensing station option

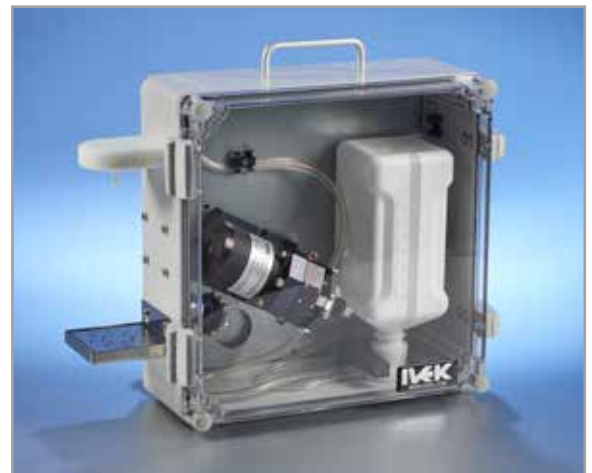

14cm x 39.5cm x 35cm



FREE Installation & Calibration of your Existing Pump with CSDS Purchase

### Controlled Substance Dispensing Station:

- 132402-01 with pump (sell with a new system)
- 132402-02 without pump (retrofit existing system)

\*Optional with IVEK's DigiSpense® 1000

## DIGISPENSE® STRIPER

### LINEAR REAGENT DISPENSING FOR LATERAL FLOW ASSAYS (LFA)

The IVEK Digispense® Striper is a semi-automatic positioning/dispensing system intended for continuous non-contact fluid dispensing onto various substrates such as nitrocellulose for manufacturing lateral flow assays (LFA). The precisely controlled motions of the vacuum plate slide carriage and IVEK dispensers together provide for extremely precise and consistent reagent line impregnation. Touch screen operation allows for immediate precise control over all system functions and has virtually eliminated the need for mechanical adjustments. The flexibility of the linear striper makes it an ideal research and development tool, as well as a full production machine. This system was created with the specific needs and requests of the diagnostic manufacturer to ensure a quality lateral flow test is the end result.

#### Features:

- Up to 8 independently controlled continuous reagent lines
- Up to 8 independently controlled dispense tip positioning fixtures
- Substrate dimensions up to 110mm x 450mm accommodated (Max Strip Length 450mm)
- Continuous fluid impregnation operator selectable from 1-450mm long
- Custom vacuum plate holds membrane substrates firmly in place
- Linear travel rate operator selectable from 1-100 mm/sec
- Accuracy/Repeatability < 1% Cv
- Capable of pumping high viscosity fluids (1,000+ cps)
- Able to Dispense Materials with Additives
- Optional Bubble Detection/Loss of Fluid Sensor(s)
- Gantry mounted dispensers for maximum accessibility to pumping chambers
- Minimum spacing between dispense tips 5 mm
- Ultra high purity ceramic dispense tips with bore sizes from 0.003"-0.007" with 0.010" and 0.012" options
- Designed for use with DigiSpense 4000 controllers:
  - Continuous dispensing rate operator selectable down through 0.1 µl/sec.
  - Dispensers fitted with 1A – 4A pump head, depending on flow volume required
  - Digital volume and flow rate control adjustment
  - LCD display of all dispensing parameters
  - Automatic pump priming and reloading
  - Micro-stepped pumps and bed for better resolution at low volume
- Computer interface – RS232 or EtherNet/IP™



Linear Reagent Striper with 2 Linear Actuators mounted (2-tips)



Dispensing 2 Reagent Lines onto Substrate

## LINEAR REAGENT STRIPER

### REAGENT DISPENSING FOR LATERAL FLOW ASSAYS (LFA)

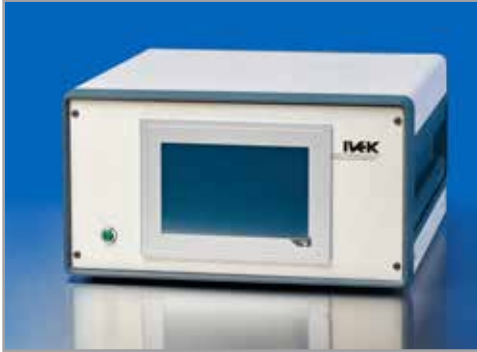

Linear Reagent Striper Controller  
19.7cm H x 36.4cm W x 39.1cm D



Linear Reagent Striper  
130.3cm L x 30.7cm W x 43cm H  
(w/out linear actuators mounted)

### Linear Reagent Striper:

192856 - # # ##

**Number of Tips**

- 1 - 1 Tip
- 2 - 2 Tips
- 3 - 3 Tips
- 4 - 4 Tips
- 5 - 5 Tips
- 6 - 6 Tips
- 7 - 7 Tips
- 8 - 8 Tips

**Vacuum Plate Groove Width**

- 1 - 0.38mm
- 2 - 0.50mm

**Options**

- 00- None



## DIGISONIC III - ULTRASONIC ATOMIZATION SYSTEM

The new Digisonic III Ultrasonic Atomization system is a robust and effective method of coating one or multiple parts from a single drive system. This system can drive up to 5 individual horns simultaneously through a single electronic module. This feature is accomplished by introducing our multi-element booster to the ultrasonic transducer. This innovative design provides all of the accuracy and effective coating characteristics of the IVEK ultrasonic atomizers while dramatically reducing equipment costs. Most of our previous horn designs are also adaptable onto the new systems. These include some of our unique and patented radial and micro-bore atomizers. Equally impressive is the improved durability and lower cost, making it a perfect solution for specialized coating applications. IVEK uses vibrational frequencies of 40 KHz (standard).

### Features:

- Titanium horns
- Submicroliter to milliliter atomization
- Autotuning electronics
- Programmable power levels
- Directional side spraying horns (360°)
- Integration with IVEK dispensing systems
- Quantitative, accurate & repeatable doses
- Multiple nozzles (max 5) from a single drive
- Airless spraying
- Reduction of overspray
- Low velocity spray
- Resistant to nozzle corrosion & fatigue
- Elimination of potential clogging
- Affordable with higher throughput
- Durable for manufacturing environments



Digisonic III Controller  
146mm H x 203mm W x 349mm D

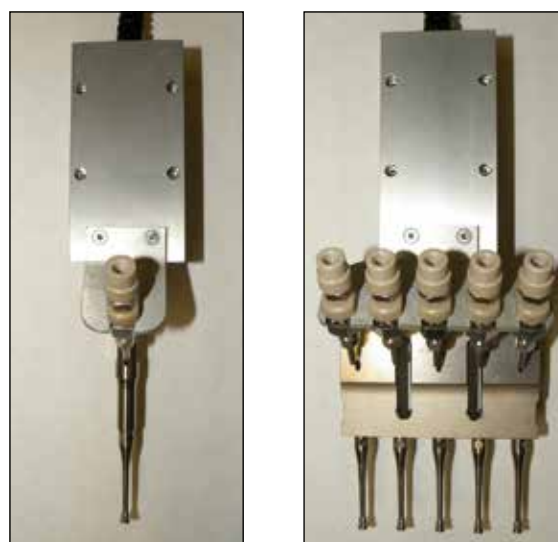

Digisonic III Titanium Horns

## DIGISONIC III - ULTRASONIC ATOMIZATION SYSTEM

### Digisonic III Controller:

520278 - # # # #

**Transducer Connector**

A - Lemo Style

**Remote Interface**

- A - 9-Pin D-Sub, w/Spade Terminal
- B - 9-Pin D-Sub, w/Terminal Block DS3000
- C - 9-Pin D-Sub w/Terminal Block DS4000BT
- D - 9-Pin D-Sub Kit for I/O Port

**Front Panel**

A - LCD w/ Amplitude Adjust,Params Monitoring

**Line Cord/CE**

- A - North American Cord, 115/230 VAC, CE
- B - International Cord 115/230 VAC, CE

### Digisonic III Components:

- 122088      Transducer
  
- 122096      Ultrasonic Fixture Assembly, 5 Element
- 122097      Ultrasonic Fixture Assembly, 1 Element
  
- 122100      Ultrasonic Horn, 40KHz, Single-Element Bar, 1-position
- 122101      Ultrasonic Horn, 40KHz, Single-Element Bar, 5-position
  
- 122045      Radial Horn
- 122049      Flat Bottem Spray Horn
- 122055      3.5" Long, 0.1100" OD Horn
- 122067      Angle Bottom Spray Horn

## SONICAIR NOZZLE - ATOMIZING SYSTEMS

IVEK's Sonicair Atomizing System is utilized for applications requiring a consistent and precise coating method. The Sonicair nozzle is manufactured from 316 stainless steel and there are no moving parts or valves that can compromise the effectiveness of the spray. Unlike many air nozzles that depend on time and pressure to atomize fluids, a ceramic positive displacement pump feeds the IVEK Sonicair nozzle. This delivers a precise volume of fluid to the nozzle; injecting it into an air stream creates an atomized field that exits the nozzle through a precision orifice. The outcome is a uniform and consistent conical or beam spray pattern. The airflow exiting the nozzle also helps to expand the spray pattern by nebulizing the spray as it travels further away from the orifice.

The Sonicair nozzle is designed to be used with IVEK systems resulting in a precise atomization that is appropriate for validated processes. The Sonicair can atomize aqueous and viscous solutions as well as suspensions with particulates. There are many different parameters that may affect a spray including temperature, viscosity and surface tension. IVEK tests each application to ensure the equipment complies to customer specifications.

IVEK's Sonicair system is particularly effective in barrel syringe and needle coatings. The system offers a solution for manufacturers looking to eliminate solvent-based lubrication formulations from their process. Many cross-linking silicones are solvent based and require dispensing in higher volumes. Evaporating solvents can cause fluctuations in the coating volume, are difficult to control and are potentially a health risk. The Sonicair nozzle has successfully atomized silicones ranging up to 100,000cps in volumes below 1mg per spray dose. Unique designs include nozzle diameters to 5mm and lengths to 90mm.

### Features:

- Volumes down to 0.3 $\mu$ l
- High repeatability
- 5-50 micron droplet size
- Low-pressure spray field
- Atomization achieved as low as 3psi
- Autoclavable
- 316 stainless steel
- Nozzle diameters down to 2.5mm OD
- Nozzle lengths to 90mm
- Heated applications
- No moving parts
- Alternative gases may be used
- Capable of high speed manufacturing



Sonicair: Body Block,  
Fitting Connections & Heater Slot



Sonicair Extended Nozzles  
5mm OD & 2.5mmOD

## SONICAIR NOZZLE - ATOMIZING SYSTEMS

### Sonicair Nozzle:

350001 - # # #

**End Cap Size**

- 1 - 0.25mm dia. Orifice
- 2 - 0.38mm dia. Orifice
- 3 - 0.50mm dia. Orifice
- 4 - 1.00mm dia. Orifice

**Cannulae Insert Size and Type**

- 1 - C'Drilled 0.25mm dia. Orifice
- 2 - C'Drilled 0.38mm dia. Orifice
- 3 - C'Drilled 0.50mm dia. Orifice
- 4 - C'Drilled 1.00mm dia. Orifice
- 5 - Thru Hole 0.50mm dia. Orifice
- 6 - Thru Hole 1.00mm dia. Orifice

**Dowel Pin**

- 0 - No Pin
- 1 - Dowel Pin

### Extended Sonicair Nozzle:

142658 - # #

**End Cap Size**

- 1 - 0.50mm dia. Orifice
- 2 - 1.00mm dia. Orifice

**Cannulae Insert Size**

- 5 - 0.50mm dia. Orifice
- 6 - 1.00mm dia. Orifice

### Extended Sonicair Nozzle:

350024 - # # # #

**End Cap Size**

- 1 - 0.50mm dia. Orifice

**Cannulae Insert Size**

- 1 - 0.50 dia for 73.88mm long
- 2 - 0.50 dia for 20mm long

**Tip Length**

- 1 - 73.88mm
- 2 - 20mm

**Not Used**

- 0



Extended Sonicair Nozzle

## OEM SERVICES

Our mechanical and electrical engineering departments provide assistance to convert an application to a ceramic design. Utilizing the finest quality precision instruments in the world, IVEK's in-house engineering staff designs and customizes its products to satisfy application requirements as necessary. IVEK controls the critical processes through in-house manufacturing. Raw materials of very simple shapes, including rods and bars, are used to manufacture most parts, including the ceramic pumps. Maintaining control over this processing has increased our quality, reliability and performance and allows for flexibility of delivery for customers when needed.

IVEK Corporation participates in R&D projects on a routine basis offering our customers the finest in OEM prototyping services. Our OEM products can range from a single component used in customer's product to whole sub-systems. This, combined with our flexible manufacturing, allows us to produce a wide variety of ceramic components for development services. By controlling these processes in-house, our customers are able to get their finished product to market quicker.

### Services Include:

- Cylindrical & flat grinding
- Cylindrical & flat lapping
- Centerless grinding
- Bisque machining & firing
- Prototype services for new designs using ceramic
- Fully staffed & tooled for prototype & production needs
- Dedicated contract manufacturing space by product line as appropriate - including inventory storage & QA activities
- Detailed work instructions, trained personnel
- Efficient work cell areas
- Pride & attention to detail – committed to quality results
- Engineering departments – experienced & available for assistance in prototype design & development



## CERAMIC LIQUID VALVES

IVEK Ceramic Liquid Valves offer a durable high-performance alternative to “plug valves” commonly used in instrumentation. Traditional plastic valves have a limited life due to material wear and leakage, requiring them to be replaced on a maintenance schedule. IVEK Ceramic Liquid Valves include ceramic rotor and stator components that are inert and offer millions of cycles without wear or degradation of performance. IVEK Ceramic Liquid Valves offer high quality solutions resulting in a total lower cost for the instrument manufacturer. These valves can be used with many of the current Syringe Pumps commercially available. Compared to traditional solenoid valves, IVEK Shear valves do not pump any fluid when moving from position to position.

### Features:

- Chemically inert
- Proven to last at least 30 times longer than KEL-F/Teflon plug valves
- Reliable operation over a wide range of temperatures
- Pressure range up to 600 PSIG (4137 KPA)
- Custom designs available
- Available for many current syringe pumps
- Ceramic sealing & wetted surface
- Wetted materials of construction: 96% aluminum oxide ceramic
- No pumping action when turning
- Free application analysis available



## AUTOPIPETTOR - PRECISION ASPIRATING & DISPENSING MODULE

IVEK's AutoPipettor has been carefully developed to provide life science instrument developers and manufacturers with an electronically controlled pipette for routine small volume liquid handling. With the looks and functionality of an electronic pipette, routine pipetting and aliquoting tasks are effortlessly managed. Functioning as an air displacement mechanism, liquid dispensing capabilities and performance are enhanced due to a closefitting ceramic-on-ceramic piston and cylinder set. The piston is coupled to and driven by a stepper motor linear actuator that creates tightly controlled piston motion, yielding outstanding accuracy, precision and reliability.

### Features:

- Four standard volume capacities: 30 $\mu$ l, 75 $\mu$ l, 150 $\mu$ l, 300 $\mu$ l
- Accuracy better than 1.0% & precision better than 0.75% CV for displacements greater than 5% of total pump displacement
- Compact & lightweight; integrated connectors simplify integration into OEM equipment
- Bipolar hybrid stepper motor linear actuator
- Motor encoder option available
- Various port fitting/tip adaptors available
- Ceramic pistons & cylinders are 100% inspected & can be individually serialized; material, dimensional, & performance certification provided upon request
- Optical end-of-stroke position sensor standard
- Wear resistant components provide unsurpassed life (>5 million cycles achievable) without need for replacement parts
- Wetted materials of construction:
  - »piston & cylinder: alumina or zirconia ceramic
  - »port fitting adaptor: consult IVEK
  - »port fitting adaptor o-ring: FKM (standard)



Autopipettor



Autopipettor

## AUTOPIPETTOR - PRECISION ASPIRATING & DISPENSING MODULE

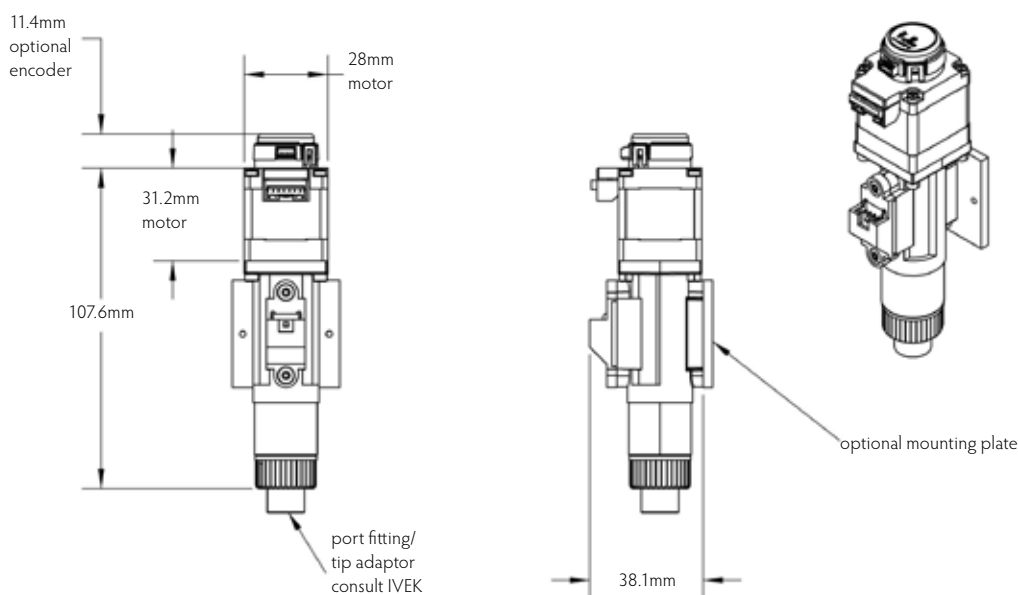

SIZE CODE	TOTAL VOLUME CAPACITY $\mu\text{L}$	RESOLUTION <sup>2</sup> $\mu\text{L}/\text{FULL STEP}$ (10 PITCH LEAD)	RESOLUTION <sup>2</sup> $\mu\text{L}/\text{FULL STEP}$ (20 PITCH LEAD)	RESOLUTION <sup>2</sup> $\mu\text{L}/\text{FULL STEP}$ (40 PITCH LEAD)
1A	300	0.40	0.20	0.10
2A	150	0.20	0.10	0.05
3A	75	0.10	0.05	0.025
4A	30	0.04	0.02	0.01

<sup>2</sup> FINER RESOLUTIONS ARE ACHIEVABLE THROUGH HALF-STEPPING AND MICRO-STEPPING

### Motor Specifications:

Size: 28mm (1.8° Step Angle)  
 Wiring: Bipolar  
 Operating Voltage: 2.1 VDC  
 Current/phase: 1.0 A  
 Resistance/phase: 2.1  $\Omega$  HM  
 Inductance/phase: 1.5 mH  
 Power consumption: 4.2 W  
 Temperature rise: 135°F (75°C)  
 Insulation resistance: 20MO  
 Connector: JST PAP-O6V-S

### Optical Sensor Specifications:

Model: Optek OPB610  
 Input Diode:  
 Forward DC Current: 50 mA, Max 10 mA, typ  
 Forward Voltage: 1.60 V Max (1f-10mA)  
 Reverse Voltage: 100 uA Max  
 Output Phototransistor:  
 Collector-Emitter Breakdown Voltage: 30 V Min  
 Emitter Reverse Current: 100 uA Max  
 Collector-Emitter Dark Current 100 mA Max  
 Coupled:  
 Saturation Voltage: 0.40 V Max  
 On-State Collector Current: 1.0 mA Min  
 Connector: JST S04B-PASK-2  
 Mating Connector: JST PAP-04V-S

### Encoder (optional):

Model: US Digital E4P  
 CPR: 100 to 360 (specify)  
 Connector: Molex 53048-0410  
 Mating Connector: Molex 51021-0400



## AUTOPIPETTOR - PRECISION ASPIRATING & DISPENSING MODULE

### Autopipettor Assembly, w/int. Connectors:

	A260175 - #	#	#
<b>Lead Screw Pitch</b>			
1 - 10 T.P.I.			
2 - 20 T.P.I.			
4 - 40 P.P.I.			
<b>Piston Size</b>			
1 - 1A			
2 - 2A			
3 - 3A			
4 - 4A			
<b>Encoder Option</b>			
0 - No			
1 - Yes			

## DISPLACEMENT PUMP - SIZE 11

IVEK's DP11 Displacement Pump designs have been carefully developed to provide IVD instrument designers and manufacturers with a small, lightweight, precise, reliable and value driven dispensing pump for most applications requiring 500 $\mu$ l or less. With the functionality of the most precise syringe pump, routine aspirating, dispensing and needle washing tasks are effortlessly managed. The small size makes this pump an ideal choice when designing multiple pumps in a compact space.

### Features:

- Standard volume capacities: 30 $\mu$ l, 75 $\mu$ l, 150 $\mu$ l, 300 $\mu$ l, & 500 $\mu$ l maximum stroke volume
- Accuracy better than 1.0% & precision better than 0.75% CV for displacements greater than 5% of total pump displacement
- Compact & customizable - designed for integration into automated systems
- Bipolar hybrid stepper motor linear actuator
- Motor encoder option available
- Various heads, manifolds & multi-pump, integrated fluidic assemblies are possible
- Optical end-of-stroke position sensing standard
- Wear resistant components provide unsurpassed life (>10 million cycles achievable) without the need for replacement parts
- Wetted materials of construction
  - »piston: zirconia ceramic
  - »head/manifold: acrylic (standard), PEEK, Ultem, stainless steel, poly carbonate & others
  - »seals: UHMWPE / FKM / ELGILOY (standard)



Size 11 Displacement Pump

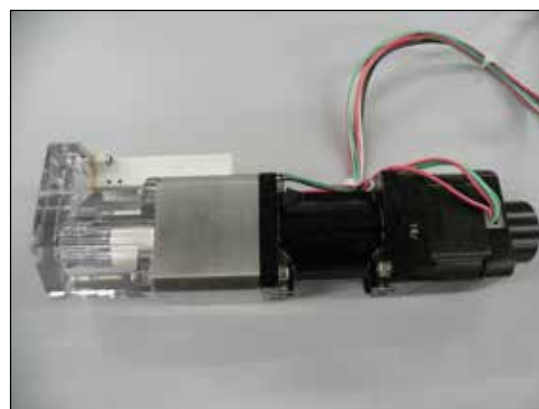

Size 11 Displacement Pump

## DISPLACEMENT PUMP - SIZE 11

size 11 displacement pump  
overall dimensions  
in millimeters (mm)

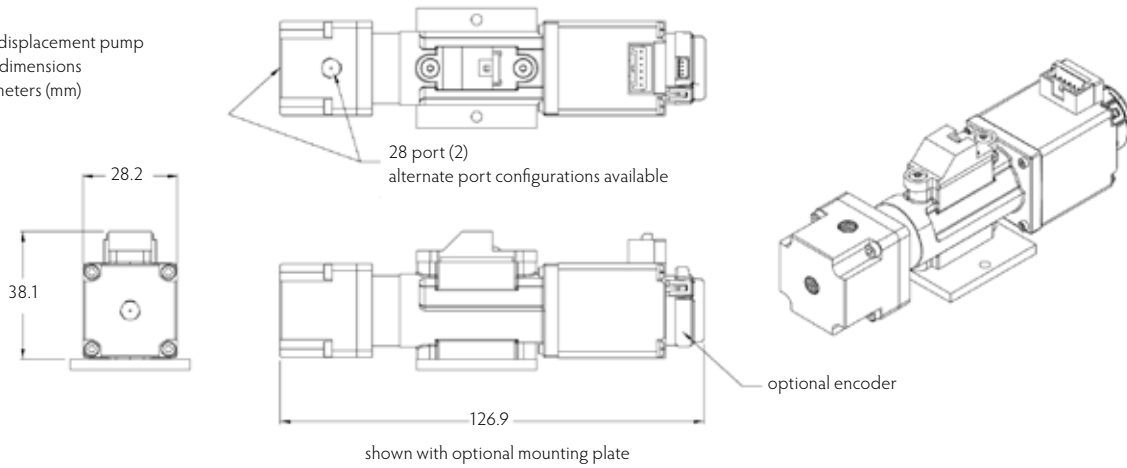

PISTON SIZE	PISTON Ø (MM)	PISTON AREA (MM <sup>2</sup> )	MAX STROKE (MM)	MAX DISPLACED VOLUME (µL)	RESOLUTION µL/ 1.8° STEP INCREMENT		
					LEADSCREW 10	LEADSCREW 20	LEADSCREW 40
4A	2.003	3.150	9.525	30	0.040	0.020	0.010
3A	3.166	7.874	9.525	75	0.100	0.050	0.025
2A	4.478	15.748	9.525	150	0.200	0.100	0.050
1A	6.333	31.496	9.525	300	0.400	0.200	0.100
A+	8.175	52.493	9.525	500	0.667	0.333	0.167

**Actuator:**

Size: 28mm Square (1.1 in.)  
 Step Angle: 1.8°  
 Power Consumption: 4.2 W  
 Temperature Rise: 75°C (167°F)  
 Wiring: Bipolar  
 Operating Voltage: 2.1 VDC  
 Current/Phase: 1.0 AMP  
 Inductance/Phase: 1.5 mH  
 Connector: JST S06B-PASK-2  
 Mating Connector: JST PAP-O6V-S

**Optical Sensor Specifications:**

Model: Optek OPB610  
 Input Diode:  
 Forward DC Current: 50 mA, Max 10 mA, typ  
 Forward Voltage: 1.60 V Max (1f-10mA)  
 Reverse Voltage: 100 uA Max  
 Output Phototransistor:  
 Collector-Emitter Breakdown Voltage: 30 V Min  
 Emitter Reverse Current: 100 uA Max  
 Collector-Emitter Dark Current 100 mA Max  
 Coupled:  
 Saturation Voltage: 0.40 V Max  
 On-State Collector Current: 1.0 mA Min  
 Connector: JST S04B-PASK-2  
 Mating Connector: JST PAP-04V-S

**Encoder (optional):**

Model: US Digital E4P  
 CPR: 100 to 360 (specify)  
 Connector: Molex 53048-0410  
 Mating Connector: Molex 51021-0400

## DISPLACEMENT PUMP - SIZE 11

### Actuator Assembly, Size 11, 3/8 Stroke, Integrated Connectors:

	A260154 - #	#
<b>Lead Screw Pitch</b>		
1 - 10 T.P.I.		
2 - 20 T.P.I.		
4 - 40 T.P.I.		
<b>Encoder</b>		
0 - No		
1 - Yes		

### Pump Heads:

<b>260164</b>	<b>4A, 30µl</b>
<b>260144</b>	<b>3A, 75µl</b>
<b>260160</b>	<b>2A, 150µl</b>
<b>260139</b>	<b>1A, 300µl</b>
<b>260156</b>	<b>A+, 500µl</b>

Partial list, there are non-standard / custom heads available.

## DISPLACEMENT PUMP - SIZE 17

IVEK's DP17 Displacement Pump designs has been engineered to provide fluidic engineers and IVD instrument designers and manufacturers with a family of precise, reliable displacement pumps for many of the fluidic requirements in today's IVD instruments. IVEK Displacement Pumps function as the most precise syringe pump, but you never need to replace the syringe. Aspirating, dispensing and needle washing routines are effortlessly performed with great accuracy and precision. IVEK's unique design and piston coupling mechanism assures precise piston movement and extraordinary seal life for worry and maintenance free operation over many years.

### Features:

- Standard volume capacities: 1000µl, 2500µl, 5000µl, 6000µl
- Inaccuracy  $\leq 1.0\%$  & imprecision  $\leq 0.75\%$  CV for displacements  $\geq 5\%$  of total pump displacement
- Designed for integration into automated systems
- Bipolar hybrid stepper motor linear actuator
- Motor encoder option available
- Various heads, manifolds and multi-pump, Integrated Fluidic Assemblies are possible
- Optical end-of-stroke position sensing standard
- Wear resistant components provide unsurpassed life (>10 million cycles achievable) without the need for replacement parts
- Wetted materials of construction
  - »piston: zirconia ceramic
  - »head/manifold: acrylic (standard), PEEK, ULTEM, stainless steel, poly carbonate & others
  - »seals: UHMWPE / FKM / ELGILOY (standard)

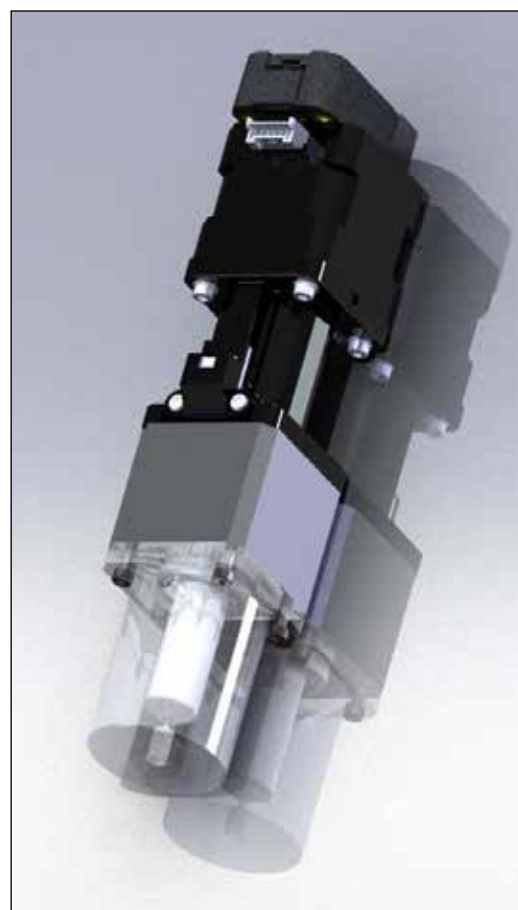

Size 17 Displacement Pump

## DISPLACEMENT PUMP - SIZE 17

size 17 displacement pump overall dimensions in millimeters (mm)

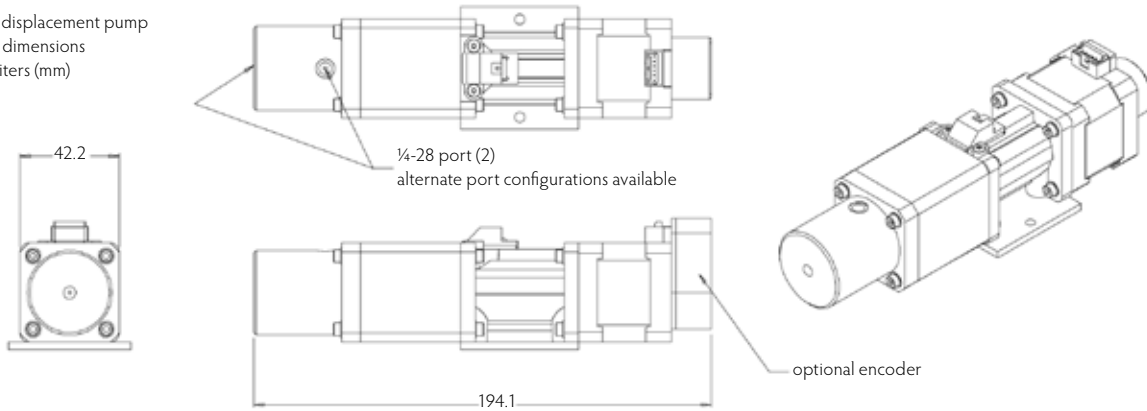

PISTON SIZE	PISTON Ø (MM)	PISTON AREA (MM <sup>2</sup> )	MAX STROKE (MM)	MAX DISPLACED VOLUME (µL)	RESOLUTION µL / 1.8° STEP INCREMENT		
					LEADSCREW 10	LEADSCREW 20	LEADSCREW 40
B	6.333	31.496	31.75	1000	0.400	0.200	0.100
C	10.013	78.740	31.75	2500	1.000	0.500	0.250
D	14.160	157.480	31.75	5000	2.000	1.000	0.500
D+	15.512	188.976	31.75	6000	2.400	1.200	0.600

**Actuator Motor:**

Size: 43mm Square (1.7 in.)  
 Step Angle: 1.8°  
 Power Consumption: 8.4 W  
 Wiring: Bipolar°  
 Operating Voltage: 2.9 VDC  
 Current /Phase: 1.2 A  
 Resistance/Phase: 1.55 OHM  
 Inductance/Phase: 2.38 mH  
 Connector: JST S06B-PASK-2  
 Mating Connector: JST PAP-06V-S

**Optical Sensor Specifications:**

Model: Optek OPB610  
 Input Diode:  
 Forward DC Current: 50 mA, Max 10 mA, typ  
 Forward Voltage: 1.60 V Max (1f-10mA)  
 Reverse Voltage: 100 uA Max  
 Output Phototransistor:  
 Collector-Emitter Breakdown Voltage: 30 V  
 Min  
 Emitter Reverse Current: 100 uA Max  
 Collector-Emitter Dark Current 100 mA Max  
 Coupled:  
 Saturation Voltage: 0.40 V Max  
 On-State Collector Current: 1.0 mA Min  
 Connector: JST S04B-PASK-2  
 Mating Connector: JST PAP-04V-S

**Encoder (optional):**

Model: US Digital E5  
 CPR: 32 to 1250 (specify)  
 Mating Connector: Molex 50-57-9405

## DISPLACEMENT PUMP - SIZE 17

### Actuator Assembly, Size 17, 1¼ Stroke, Integrated Connectors, Front A/B:

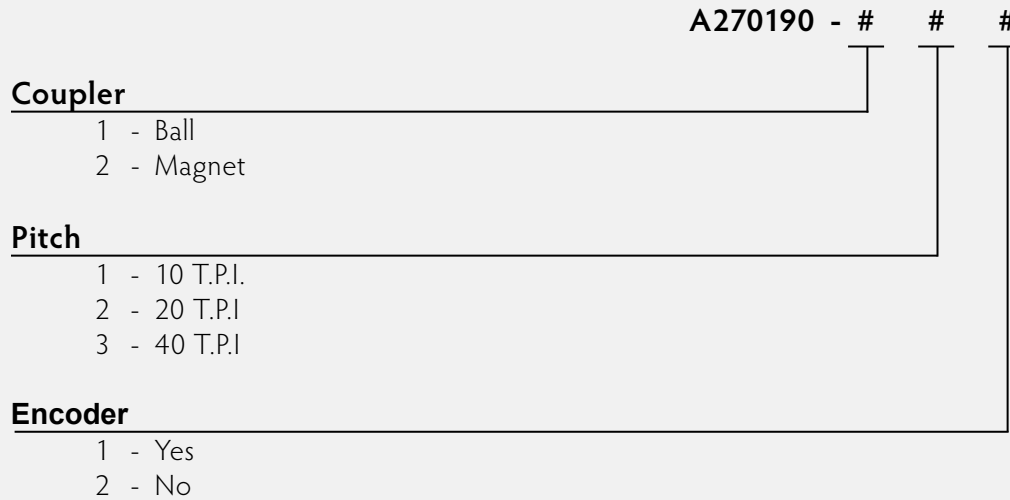

### Actuator Assembly, Size 17, 1¼ Stroke, Integrated Connectors, Rear A/B:

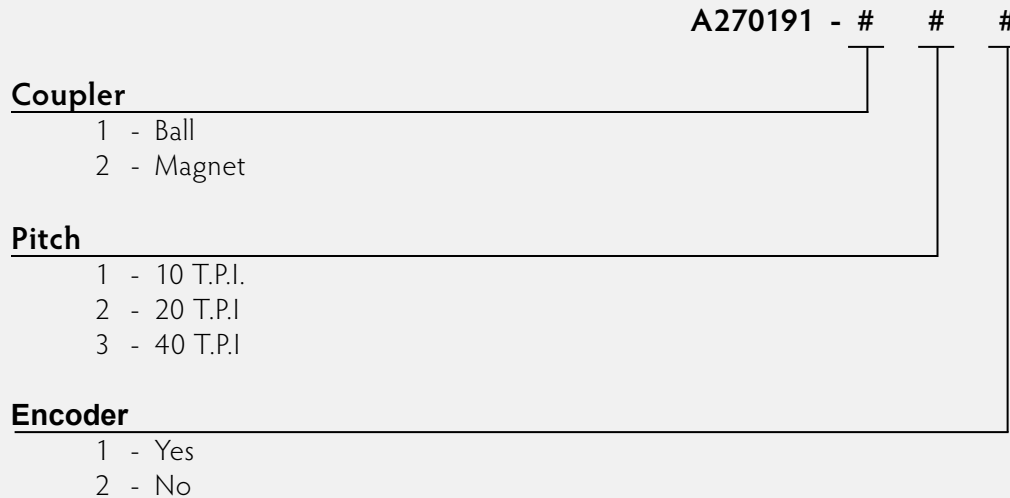

### Pump Heads:

- 270163 B-size, 1ml
- 270177 D-size, 5ml
- 270183 D+, 6ml

## METERING PUMPS

IVEK's rotary/reciprocating Metering Pumps provide exceptional precision and reliability for many applications where fast and precise dispensing of fluids are required. Applications such as pump or system priming, washing fluid lines, needle or probe purging, recharging filters or columns and continuous flow applications are all possible with IVEK Metering pumps. The simplicity of a valve-less, seal-less design with the ease of single motor control makes these pumps extremely versatile. Since they are a true displacement pump capable of holding significant pressure, they can be used as an alternative to peristaltic pumps where great precision and reliability is required.

### Features:

- Large flow range
- Compact design
- Various pumps sizes available to optimize your application
- Wear resistant components provide unsurpassed life (>10 million cycles achievable) without the need for replacement parts
- Wetted materials of construction
  - »piston: alumina or zirconia
  - »end cap: PTFE
  - »o-ring: FKM standard



Metering Pump  
Shown Mounted on Custom Motor/Base Assembly

PISTON SIZE	PISTON Ø (MM)	PISTON AREA (MM <sup>2</sup> )	MAX STROKE (MM)	MAX DISPLACED VOLUME (µL)	FLOW RATE ML/MIN@ 500 RPM
B	6.333	31.496	9.365	295	147
C	10.013	78.740	9.365	739	369
0.5	12.700	126.677	9.365	1186	593



## METERING PUMPS

### Poly Case Pump (pump only, no motor/base):

250044 - # # # # #

**Piston/Cylinder Size**

- 1 - B w/out Gland
- 2 - B w/ Gland
- 3 - C w/out Gland
- 4 - C w/ Gland
- 5 - 12.7 w/out Gland
- 6 - 12.7 w/ Gland
- 7 - B w/ Lip Seal
- 8 - C w/ Lip Seal
- 9 - 12.7 w/ Lip Seal

**Case Size/Type**

- 1 - .250-28 w/out Gland
- 2 - .250-28 w/ Gland
- 3 - .312-24 w/o Gland
- 4 - .312-24 w/ Gland

**Port Gasket Option**

- 0 - No Port Gasket
- 1 - .250 Gasket
- 2 - .312 Gasket

**Piston Lip Seal Option**

- 0 - No Lip Seal
- 1 - B Lip Seal
- 2 - C Lip Seal
- 3 - 12.7 Lip Seal

**O-Ring Material**

- 1 - Buna-N
- 2 - Ethylene Propylene
- 3 - Kalrez
- 4 - Polyurethane
- 5 - Silicone
- 6 - Teflon
- 7 - Teflon Encapsulated Silicon
- 8 - Viton
- 9 - Teflon Encapsulated Viton

## FLUID CIRCULATION MODULE

IVEK's Fluid Circulation Module is a self-contained liquid metering system in a compact enclosure. This Fluid Circulation Module has been designed to continuously meter fluid at a low flow rate while providing excellent chemical compatibility. The Module operates on a stand-alone basis or as an auxiliary unit to an IVEK dispensing system that is performing an application requiring a fluid to be circulated through a gland port machined into the dispensing pump. Applications that frequently require a gland pump include: clean-in-place (CIP) flushing, cyanoacrylate dispensing, and electrolyte dispensing.

### Features:

- Forward / reverse
- Choice of two pump sizes; 54 $\mu$ l & 109 $\mu$ l maximum displacement per revolution
- Flow ranges for 50 $\mu$ l capacity pump to 3000 $\mu$ l/minute (60rpm) & 3600 $\mu$ l/minute (72rpm)
- Flow ranges for 100 $\mu$ l capacity pump to 6000  $\mu$ l/min (60rpm) & 7200 $\mu$ l/minute (72rpm)
- On/off switch & front panel power indicator
- Variable flow rate by changing pump displacement volume
- Motor speed 60 RPM for 50Hz systems & 72 RPM for 60Hz systems
- Pump case available in 316 stainless steel and Tefzel
- Available in 115VAC or 230VAC models
- North American or International line cord
- CE certified



Fluid Circulation Module  
with Pump Module

### Fluid Circulation Module:

#### Motor Configuration

- 1 - AC Synchronous, 115 VAC
- 2 - AC Synchronous, 230 VAC

#### Enclosure

- 1 - Stainless Steel, 115 VAC
- 2 - Stainless Steel, 230 VAC

#### Cord & Agency Approval

- A - North American, CE
- B - International (No Plug), CE

520281 - # # #

## HEATER SYSTEM

The Heater System is an accessory commonly used to elevate temperature of an IVEK Pump Module or Sonicaire Spray Nozzle. The Heater System consists of a controller, cartridge heater and thermocouple. This can improve dispensing or spraying performance by lowering the fluid viscosity. The temperature is digitally selectable on the front panel of the controller and the heater and thermocouple plug into connectors on the controller. These components provide closed loop feedback to keep the heated component at the preset temperature.

**Features:**

- Temperature displayed in either °F or °C
- Temperature selectable to 250°F (121°C)
- Extended length custom heaters available
- Multi-channels available
- CE certificate available



Single Channel Heater System Controller



Double Channel Heater System Controller

### Heater System

Single Channel 520271 - # #

Double Channel 520232 - # #

**Alarm Output**

C - Output Alarm (CC)

**Power Connection / CE**

C - North American Cord, 115 VAC & CE

D - International Cord, 230 VAC & CE

**The following Heater Kits are also available:**

- 092271-3 Heater Kit Split Case Pump, 120 VAC, 16 inch
- 092271-4 Heater Kit Split Case Pump, 240 VAC, 16 inch
- 092271-5 Heater Kit, Split Case Pump, 120 VAC, 76 inch
- 092271-6 Heater Kit, Split Case Pump, 240 VAC, 76 inch

- 102181-3 Heater Kit, MicroSpense® Pump, AP Rotary & Linear, 120 VAC, 16 inch
- 102181-4 Heater Kit, MicroSpense® Pump, AP Rotary & Linear, 240 VAC, 76 inch
- 102181-5 Heater Kit, MicroSpense® Pump, AP Rotary & Linear, 120 VAC, 16 inch
- 102181-6 Heater Kit, MicroSpense® Pump, AP Rotary & Llinear, 240 VAC, 76 inch

## LIQUID EYE - OPTICAL LIQUID DETECTOR

IVEK's Liquid Eye provides for detection of liquid or air inside translucent tubing for critical dispensing applications. The system consists of a detector and a controller. The controller includes solid-state electronics for maximum reliability. The system is based on a principle of high frequency, multipath reflection, and it is insensitive to background light intensity. The detectors are available in standard size tubing from 3.0mm (0.125") up to 16.10mm (0.625") with custom sizes available. The detection circuitry has front panel gain and intensity adjustments for tailoring the sensitivity to accommodate a wide range of fluids, including clear, colored or turbid solutions and some slurries. The system operates in a "continuous" mode where the alarm is active during the time air is present in the tube. Through a simple toggle switch this mode can be changed to "latch" the alarm, which requires the system to be manually reset to turn off the alarm. The alarm signal can be made audible through an additional toggle switch for this feature. The alarm status is also available as a contact closure signal located on a connector.

### Features:

- Prevent air from entering a process
- Prevent loss of prime in a dispenser
- Reduce waste & downtime in a process
- Audible and visual alarm activated before non-compliant product is manufactured
- Detection of optical properties changing in a fluid
- Multi-channels available
- Mountable to either a wall or DIN rail
- Logic I/O for interfacing PLCs
- Universal power supply
- RoHS compliant
- CE certified



Liquid Eye System  
19.9cm x 17.8cm x 10.2cm



Liquid Eye Sensors



Liquid Eye Sensors

## LIQUID EYE - OPTICAL LIQUID DETECTOR

### Liquid Eye (Bubble Detector):

520228 - # # #

**Detector Style**

- A - Standard Through Hole
- B - Surface Mount

**Logic Interface**

- B - Relay, Red Power & Yellow Detector Leds

**Power Cord**

- A - North American
- B - International

### Multiple Channel Liquid Eye (Bubble Detector):

**Front Connector**

- 1 - 6 Channel Enclosure 520174 - # ## # #
- 7 - 10 Channel Enclosure 520176 - # ## # #
- 11 - 20 Channel Enclosure 520178 - # ## # #

**Rear Connector**

- 1 - 12 Channel Enclosure 520182 - # ## # #

**Liquid Eye Sensor Setup**

- J - Universal Setup

**Number of Installed Channels**

- 01 - 40 (per Enclosure)

**Interface**

- G - Standard

**Power Cord**

- E - North American
- F - International

### Liquid Eye Sensor:

152034 - # ##

**Body Material**

- 1 - Aluminum
- 2 - Delrin, BLK

**Tubing O.D.**

- 01 - 3mm
- 02 - 1/8"
- 03 - 4mm
- 04 - 3/16"
- 05 - 6mm
- 06 - 1/4"
- 07 - 5/16"
- 08 - 3/8"
- 09 - 10mm
- 10 - 7/16"
- 11 - 1/2"

## SMALL VOLUME DISPENSE NOZZLES

IVEK offers a wide variety of small volume dispense orifices and nozzles to compliment our precision fluid metering and dispensing systems. Typically used in conjunction with our small volume dispensing systems and micro pumps, these nozzles augment the delivery of extremely precise fluid volumes. Our nozzles include ceramic, peek, sapphire and stainless steel orifices, whose natural properties of extreme hardness, chemical inertness and wear resistance make them ideal choices when extremely precise liquid flow control is needed. They serve as a valuable addition to IVEK's line of precision small volume dispensing and metering systems. IVEK custom designs and/or specifies commercially available nozzles to meet application requirements as required.

### Features:

- Accurate & repeatable orifice diameters ranging from 0.003" – 0.020"
- Ceramic, 316 stainless steel, Sapphire, PEEK wetted components
- Custom materials available
- Hydrophobic coatings available
- Wear & chemically resistant
- Application analysis to specify nozzle size & type



Assorted Nozzles

## DEGASSER

Some fluids contain air or other gaseous impurities that cause inaccuracies during dispensing. A degasser is designed to remove the air or gaseous impurities from the fluid to help improve your end results. This unit is the perfect size for the laboratory and is easy to operate. Please contact us for more information about this product.



Degasser

## VALIDATION GUIDELINES - TEMPLATE

Precision and accuracy are the benchmarks of IVEK's liquid dispensing systems. Because these elements are vital to your packaging machinery's success, IVEK has developed a comprehensive Validation Guidelines Template providing a smooth transition from set-up, to testing, to production. We offer a multi-page template allowing you to document and test our systems before putting them into production. At a reasonable cost, this template will enable you to perform Installation Qualification/Operational Qualification (IQ/OQ) and Performance Qualification (PQ) tests for good manufacturing practices.

### Features:

- Accurately documents & tests the system prior to production
- Performs IQ/OQ & PQ requirements
- Is an easy-to-follow step-by-step worksheet giving you the simple mapping you need to fulfill your validation requirements
- Saves you & your company valuable time as you do not need to develop your own testing template
- Is available in two easy formats, disc or hard copy - your choice for easy record keeping
- Identifies & tests all functions of the system as defined within the requirements in the validation guidelines template

## Terms and Conditions of Sale:

1. **Acceptance of Terms and Conditions of Sale:** By placing an order with IVEK Corporation ("IVEK"), Buyer agrees to be bound by these Terms and Conditions of Sale. IVEK shall not be bound by any other terms and conditions, regardless of whether Buyer tenders terms and conditions with an order or otherwise. These Terms and Conditions of Sale supersede all prior or contemporaneous oral or written communications, proposals and representations with respect to its subject matter and shall prevail over any conflicting or additional terms of any quote, order, previous agreement, acknowledgment or similar communications between IVEK and Buyer. As used in these Terms and Conditions of Sale, "Product" or "Products" includes all physical IVEK Products, individually and collectively.
2. **Pricing:** All prices are quoted in US dollars unless otherwise expressly stated and are valid for 30 days. Buyer is solely responsible for payment of all shipping charges, freight costs, taxes, import fees and duties, insurance, value added taxes, and any other charge incident to Buyer's receipt of Products ("Additional Charges").
3. **Payment:** Unless otherwise agreed in writing by IVEK, payment to IVEK shall be made in advance by electronic funds transfer in U.S. dollars. A late payment charge of one and a half (1.5%) percent per month, or the maximum percentage rate permitted by law, if lower, shall be charged on all past due balances. Buyer agrees to pay all costs and expenses incurred by IVEK in collecting or attempting to collect past-due balances, including, but not limited to, third party collection fees, reasonable attorneys' fees, legal expenses and court costs.
4. **Shipping Terms:** All Products delivered by IVEK to Buyers in the United States shall be FCA IVEK's distribution center Incoterms® 2010, with risk of loss passing to Buyer upon IVEK's delivery of the Products to a common carrier. All Products delivered by IVEK to Buyers outside the United States shall be DAP Buyer's facility Incoterms® 2010. Where IVEK arranges for shipping, the costs of shipping and insurance will be added to Buyer's invoice. If Buyer arranges shipping, then prior to shipment it shall provide IVEK with a certificate of insurance for the full value of the goods to be shipped. Delivery times quoted are estimates only and IVEK shall not be liable for delays in delivery.
5. **Acceptance by Buyer, Cancellations & Returns:**
  - (a) **Acceptance by Buyer.** Shipments shall be deemed to be accepted by Buyer upon receipt of shipment. Any discrepancy in shipment quantity must be reported to IVEK within five (5) days of Buyer's receipt of shipment.
  - (b) **Cancellations.** Buyer may cancel any order without incurring any charges within seventy-two (72) hours from the time Buyer e-mails or faxes its Purchase Order or a signed and dated copy of IVEK's Order Acknowledgment. Any cancellation thereafter but prior to shipping shall be subject to a re-stocking fee of thirty-five percent (35%) and payment of all custom engineering fees related to the Products on the Purchase Order or Order Acknowledgment. Cancellations after shipment are subject to paragraph (c) below.
  - (c) **Returns.** Except for those Products which are sold to Buyer as not returnable, Buyer may return any Product to IVEK, provided, however, that as a condition to such return, Buyer must: i) comply with paragraph 11 below; ii) pay IVEK a re-stocking fee of thirty-five percent (35%) of the purchase order price for such Product; and (iii) pay IVEK all custom engineering fees related to such Product. IVEK shall not be obligated to accept for return any Product which is damaged after it leaves IVEK's premises or distribution point. Upon acceptance of a return by IVEK, IVEK shall issue a credit to Buyer of the applicable amount, which credit may be used only against future purchases or other outstanding invoices.
6. **Compliance with Laws, Rules & Regulations:** Buyer acknowledges and accepts that: i.) Products may be exported from the United States only in accordance with US Export Administration Regulations and diversion contrary to US law is prohibited. Accordingly, Buyer warrants and represents that it is eligible to receive Products under US law and the laws of Buyer's jurisdiction and Buyer agrees to abide by all export, import and re-export restrictions; ii.) Buyer shall be solely responsible for compliance with all laws, rules and regulations pertaining to the use of any Product, including without limitation any use that requires approval from any governmental entity or authority with respect to research, testing or use in commerce; iii.) Products sold for biomedical purposes shall only be used for research purposes; iv.) any approval required by the US Food and Drug Administration, Internal Review Board (IRB), Human or Animal Experimentation Committee or other governmental entity or authority, whether of the US or any other jurisdiction, must be obtained by Buyer at its sole cost and effort; v.) IVEK expressly disclaims compliance with any and all such laws, rules, and regulations; and vi.) Buyer accepts full and complete responsibility for any such compliance.
7. **Limited Warranty:** IVEK WARRANTS AND REPRESENTS THAT, UNLESS IVEK SPECIFIES OTHERWISE IN WRITING, ALL PRODUCTS SHALL BE FREE FROM MATERIAL DEFECTS IN MATERIALS AND WORKMANSHIP FOR A PERIOD OF ONE (1) YEAR FROM THE DATE OF SHIPMENT BY IVEK TO BUYER. THE FOREGOING WARRANTY EXTENDS ONLY TO THE ORIGINAL BUYER AND SUCH WARRANTY IS EXPRESSLY IN LIEU OF ALL OTHER WARRANTIES, EXPRESS OR IMPLIED, OF ANY KIND OR NATURE. EXCEPT FOR THE SPECIFIC WARRANTIES HERETOFORE DESCRIBED, IVEK EXPRESSLY DISCLAIMS ALL WARRANTIES OF MERCHANTABILITY OF GOODS OR OF FITNESS FOR A PARTICULAR PURPOSE OR ANY PURPOSE. BY ACCEPTING DELIVERY OF ANY PRODUCT, BUYER ACKNOWLEDGES AND AGREES THAT IVEK HAS MADE NO REPRESENTATIONS OR WARRANTIES, EXPRESS OR IMPLIED, TO OR FOR THE BENEFIT OF BUYER WHICH CONTRADICT ANY OF THE FOREGOING.



## TERMS &amp; CONDITIONS OF SALE

8. What Is Not Covered: Notwithstanding the Limited Warranty contained in paragraph 7 above, such Limited Warranty does not cover: i) any Product which, in IVEK's sole judgment, has been subjected to abuse, accident, alteration, modification, tampering, negligence, misuse, faulty installation, lack of reasonable care, repair or service in any way that is not contemplated in the documentation for such Product; ii) any Product, the model or serial number of which has been altered, tampered with, defaced or removed; iii) the initial installation, installation and removal of any Product for repair; iv) shipping costs; v) operational adjustments covered in the operating manual for such Product; vi) normal maintenance; vii) damage occurring in shipment or due to acts of nature, terrorism, failures due to power surge or other force majeure causes; viii) cosmetic damage; ix) any hardware, software, firmware or other Product or service provided or furnished by anyone other than IVEK; x) Products that have been used outside IVEK's technical specifications for such Product; xi) refurbished Products; and xii) Products which have been purchased through an inventory clearance or liquidation sale or other sale specifying that such Product is being sold "as is." Repair by anyone other than IVEK will void any applicable warranties.

9. Limitation of Liability and Indemnification: IN NO EVENT SHALL IVEK BE LIABLE FOR SPECIAL, DIRECT, INDIRECT, INCIDENTAL OR CONSEQUENTIAL DAMAGES, INCLUDING BUT NOT LIMITED TO LOSS OF PROFIT OR OPPORTUNITY OR ANY DAMAGE WHICH MAY ARISE, IN WHOLE OR IN PART, FROM OR IN CONNECTION WITH THE USE, MISUSE OR NONUSE OF ANY PRODUCT. BUYER'S SOLE AND EXCLUSIVE REMEDY SHALL IN NO EVENT EXCEED THE REPAIR, REPLACEMENT OR COST OF THE SPECIFIC PRODUCT PURCHASED FROM IVEK. BUYER HEREBY INDEMNIFIES IVEK AND ITS PRINCIPALS, SHAREHOLDERS, OFFICERS, EMPLOYEES, INDEPENDENT CONTRACTORS, AGENTS AND DISTRIBUTORS ("RELATED PARTIES") FROM AND AGAINST ANY AND ALL LIABILITIES, DAMAGES, COSTS AND EXPENSES (INCLUDING REASONABLE ATTORNEYS' FEES, COURT COSTS AND LEGAL EXPENSES) ARISING OUT OF OR RELATED TO: i) ANY USE OF ANY PRODUCT BY BUYER OR UNDER BUYER'S DIRECTION, CONTROL OR AUTHORIZATION, WHETHER SUCH USE IS OF THE PRODUCT ALONE OR IN CONJUNCTION WITH OTHER PRODUCTS OR GOODS, TANGIBLE OR INTANGIBLE; AND ii) ANY BREACH BY BUYER OF ANY WARRANTY, REPRESENTATION, COVENANT OR ACKNOWLEDGEMENT MADE BY BUYER IN THESE TERMS AND CONDITIONS OF SALE.

10. Warranty Repair: IVEK's sole obligation with respect to any Product which is found to contain any material defect in materials or workmanship within the applicable warranty period shall be, at IVEK's sole discretion, either to repair or replace such Product at no charge to the original Buyer, or to refund the purchase price upon return of the defective Product to IVEK. The replacement Product need not be new (i.e., it may be used or reconditioned) or be of identical make, model or part, so long as IVEK has reasonably determined that it is substantially equivalent or superior in all material respects to the Product being replaced. Repaired or replacement Products will be warranted for the remainder of the original applicable warranty period. All Products (including any part thereof) replaced by IVEK or for which the purchase price is refunded shall become the property of IVEK upon replacement or refund. All Warranty Repair returns shall comply with IVEK's return policy provided in paragraph 11 below.

11. RMA and Warranty Repair Return Policy: If the Product is believed to be defective and is still in warranty, or if IVEK has otherwise agreed to accept return of a Product, the Buyer shall: i.) if the Product is alleged to be defective, provide IVEK with a written description in sufficient detail to allow IVEK to confirm such defect; ii.) obtain a Return Merchandise Authorization (RMA) number from IVEK; iii.) if requested by IVEK, provide written proof of purchase of the Product (such as a copy of the dated purchase invoice for the Product); iv) after an RMA number is issued, package the Product securely in the original or other suitable shipping package to ensure that it will not be damaged in transit, with the RMA number prominently marked on the outside of the package; and v.) within fifteen (15) days of issuance of the RMA, ship the Product at Buyer's sole expense to IVEK or its distribution point, as indicated by IVEK. In addition:

- If the Product is being returned for repair, Buyer must not include any manuals or accessories in the shipping package. IVEK will only replace the defective portion of the Product and will not ship back any accessories;
- Buyer is responsible for all shipping charges to IVEK. No Cash on Delivery ("COD") is allowed. Products sent COD will either be rejected by IVEK or become the property of IVEK, at IVEK's sole discretion.
- Buyer shall fully insure any Product for return to IVEK and IVEK shall in no event be responsible for any shipment lost in transit.
- Repaired or replaced Products will be shipped to Buyer via any common carrier selected by IVEK, with shipping charges prepaid by IVEK. Expedited shipping is available if shipping charges are prepaid by Buyer and only upon request.
- IVEK may reject or return any Product that is not packaged and shipped in strict compliance with the foregoing requirements or for which an RMA number has not been obtained or is not visible from the outside of the package. The Product owner agrees to pay IVEK's reasonable handling and return shipping charges for any Product that is not packaged and shipped in accordance with the foregoing requirements or that is determined by IVEK not to be defective or non-conforming.

12. Copyright Statement: No publication or documentation regarding, accompanying or contained in any Product may be reproduced, in whole or in part, in any form or by any means, or used to make any derivative work, including without limitation any translation or adaptation, without IVEK's prior written consent.

13. Force Majeure. Except for the obligations to make payments, neither party shall be bound to meet any obligation if prevented from doing so as a consequence of force majeure.

14. Notice: All notifications and communications between the parties relating to this Agreement or the subject matter hereof shall be made in writing and signed by a person duly authorized to provide such notice.

15. Entire Agreement: These Terms and Conditions of Sale shall not be modified or amended, except in writing and signed by Buyer and IVEK.

16. No Assignment by Buyer: These Terms and Conditions of Sale may not be assigned, sublicensed, leased, sold or otherwise transferred by Buyer without prior written consent from IVEK, and any transfer made without such prior written consent shall be null and void. These Terms and Conditions of Sale and any rights granted herein by IVEK are personal to Buyer.

17. Enforceability/Severability: If any provision of these Terms and Conditions of Sale shall be held void, voidable, invalid or inoperative, no other provision hereof shall be affected as a result, and accordingly, the remaining provisions shall remain in full force and effect as though such void, voidable, invalid or inoperative provision had not been contained herein, provided, however, that if such void, voidable, invalid or inoperative provision is a material term or condition, the parties shall be compelled to supply a substitute provision, negotiated in good faith, which comes closest to their original intention.

18. Waiver: No provision of these Terms and Conditions of Sale shall be deemed to have been waived by any act or acquiescence on the part of either party, it being understood that waiver may only occur by an instrument in writing signed by an authorized officer of the party against whom such waiver is sought to be enforced. In the event of a waiver, whether in writing or by operation of law, such waiver shall not constitute a waiver of any other provision or of the same provision on another occasion.

19. Cumulative Remedies: All rights and remedies of the parties, whether at law or in equity, shall be cumulative and none of them shall be in limitation of any other right or remedy.

20. Rights of Third Parties: Nothing in these Terms and Conditions of Sale shall be construed so as to give any right or remedy to any third party whatsoever.

21. Governing Law: THE SALE OF PRODUCTS BY IVEK AND THESE TERMS AND CONDITIONS OF SALE, TOGETHER WITH ALL INVOICES, CORRESPONDENCE AND OTHER DOCUMENTS EXCHANGED BETWEEN IVEK AND BUYER, SHALL BE GOVERNED BY AND CONSTRUED IN ACCORDANCE WITH THE LAWS OF THE STATE OF VERMONT, USA, WITHOUT REGARD TO PRINCIPLES OF CONFLICTS OF LAW OR TO THE UNITED NATIONS CONVENTION ON CONTRACTS FOR THE INTERNATIONAL SALE OF GOODS (CISG), WHICH IS HEREBY SPECIFICALLY DISCLAIMED BY THE PARTIES WITH RESPECT TO ALL OF THE FOREGOING. Any action, suit or proceeding arising out of or related to these Terms and Conditions of Sale, the documents heretofore described and the related subject matter of the foregoing shall be brought only in a federal or state court of competent jurisdiction located in the county in which IVEK has its principal place of business at the time of filing of such action, suit or proceeding, and the Parties hereby unconditionally and irrevocably consent and submit to such exclusive jurisdiction and waive any objection that either of them may now or hereafter have with respect thereto.

22. Headings: The paragraph headings in these Terms and Conditions of Sale are solely for the convenience of the parties and have no legal or contractual significance.

© 2023 IVEK Corporation. All rights reserved. The Products may be protected by U.S. patents, with other patents pending in the USA and elsewhere. IVEK and other marks indicated on our website and the logo forms of the foregoing marks are trademarks and/or service marks of IVEK and may be registered in the United States or in other jurisdictions including internationally. IVEK's trademarks, service marks and trade dress may not be used in connection with any product or service that is not affiliated with IVEK or in any manner that is likely to cause confusion among customers or disparages or discredits IVEK. All other trademarks not owned by IVEK that appear on IVEK's website or in Product literature or manuals are the property of their respective owners who may or may not be affiliated with, connected to or sponsored by IVEK.

ISO 9001 CERTIFIED  
ISO 13485 CERTIFIED



IVEK CORPORATION  
10 FAIRBANKS ROAD  
NORTH SPRINGFIELD  
VERMONT USA  
05150

TEL: 802.886.2238  
1.800.356.4746  
FAX: 802.886.8274

EMAIL: [IVEK@IVEK.COM](mailto:IVEK@IVEK.COM)  
[WWW.IVEK.COM](http://WWW.IVEK.COM)